

SERVICE MANUAL

SAAB

SONETT III

Ordering No. 10150

Supplement to Service Manual for SAAB V4

SAAB-SCANIA AKTIEBOLAG
Saab Car Division

Nyköping Sweden

Copyright Saab-Scania AB

Endast för spridning utomlands.

SPECIFICATIONS, TROUBLE SHOOTING	0
TOOLS, SERVICE, MAINTENANCE	1
ENGINE	2
ELECTRICAL SYSTEM	3
TRANSMISSION	4
BRAKE SYSTEM	5
FRONT ASSEMBLY, STEERING,	6
SUSPENSION, WHEELS	7
BODY	8
INSTRUMENTS, HEATING SYSTEM ACCESSORIES	9

FOREWORD

This Service Manual for the Saab Sonett III deals with the sections where there are differences from the Saab V4. Thus, this manual may actually be considered as a supplement intended for use together with the Service Manual of Saab V4.

SAAB-SCANIA AKTIEBOLAG
Saab Car Division
NYKÖPING
SWEDEN

Production: Technical Publications, Saab-Scania, Trollhättan, Sweden.
Printed by Gotab, Kungälv.

CONTENTS

- 010 General**
- 020 Specifications**
- 030 Trouble shooting***

***) See Service Manual Saab V4.**

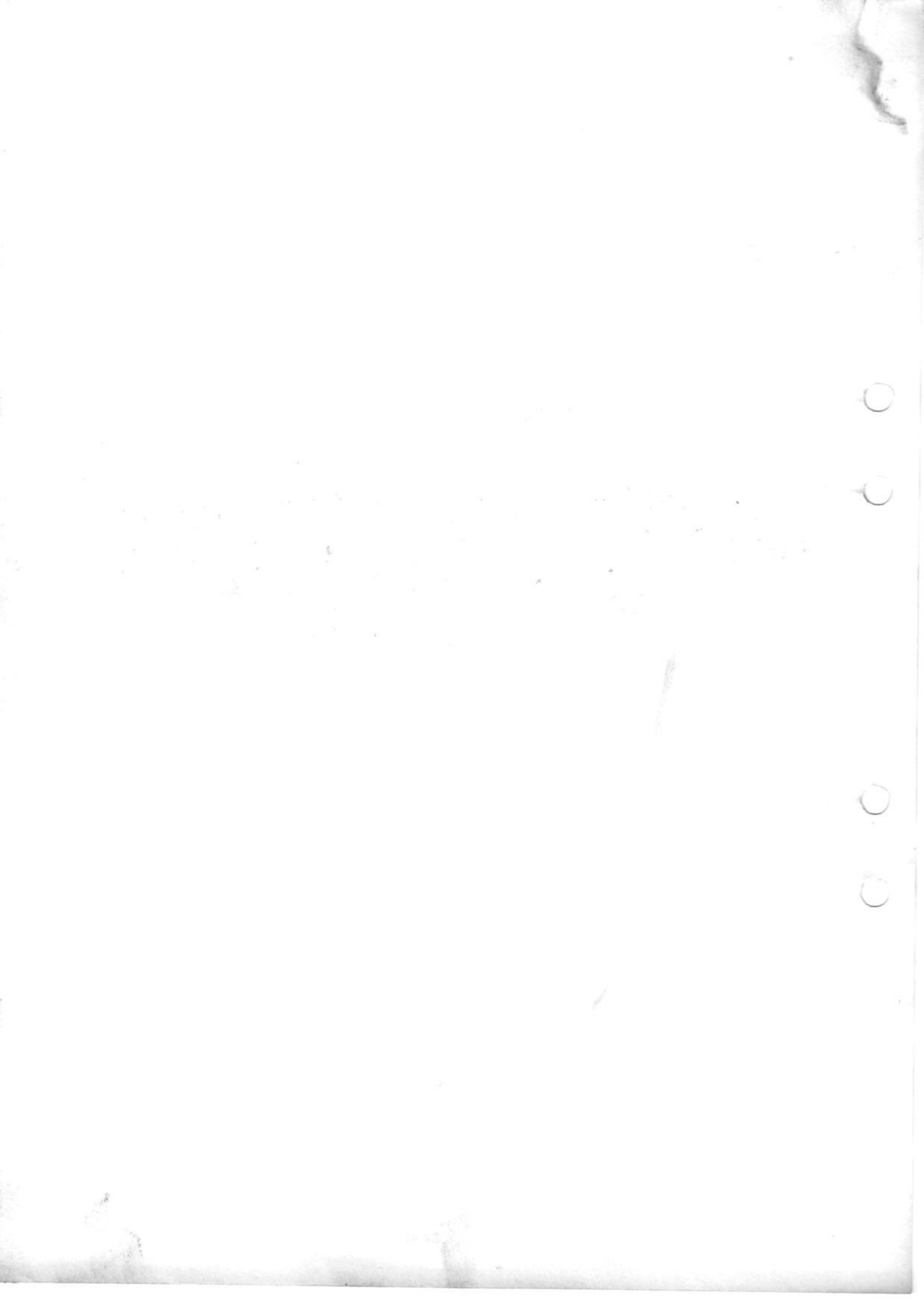



S 3797

EXTERIOR SAAB SONETT III

CHASSIS AND ENGINE NUMBERS

The illustrations below show the locations of the chassis and engine numbers. To ensure correct identification in the case of a particular car or engine, these numbers, together with the mileage, must always be quoted in warranty claims, etc. If a service engine is fitted in a car, the number of the original engine must, without fail, be stamped in the appropriate place. This is of the utmost importance if customs difficulties are to be avoided in the event that the car is subsequently used in a country other than that of registration.

Chassis numbers as from model 1972

As from model 1972, the chassis number consists of eleven digits. Explanation of the digits is shown in the following example:

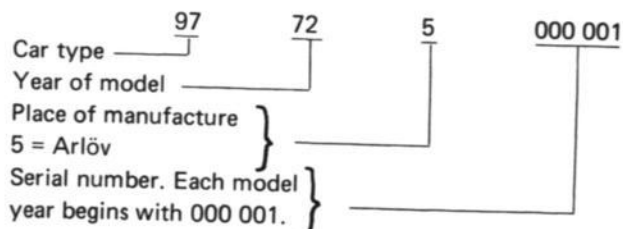

Chassis number limits for the year models

Saab 97 Sonett III 1970: 70500001—70500303
 Saab 97 Sonett III 1971: 71500001—71501265
 Saab 97 Sonett III 1972: 97725000001—97725002000
 Saab 97 Sonett III 1973: 97735000001—97735002300
 Saab 97 Sonett III 1974: 97745000001—

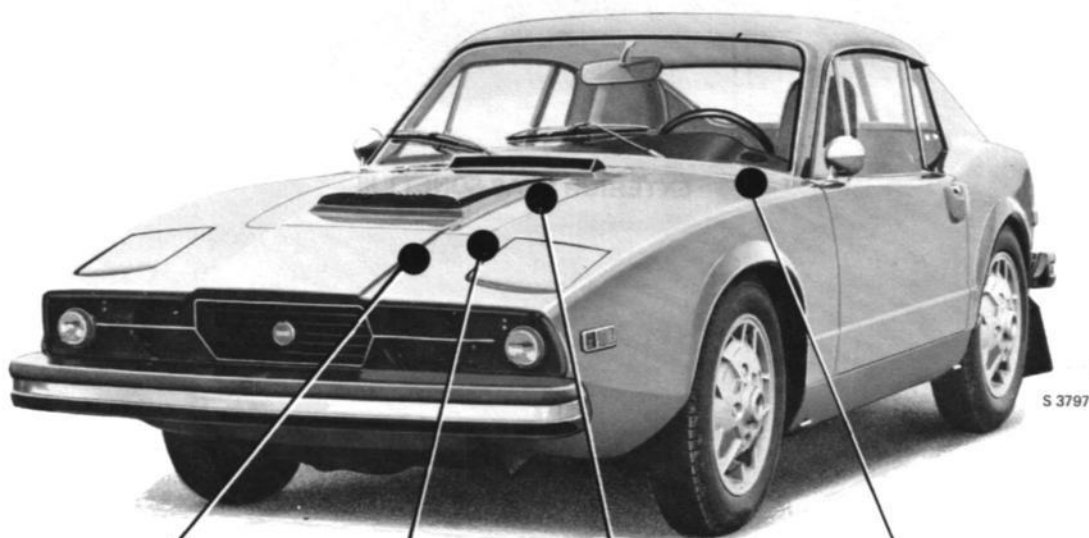

S 3797



Engine number



Gearbox number

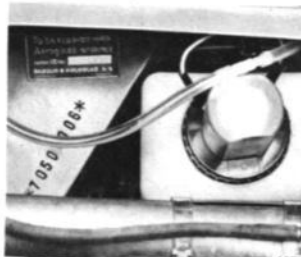

Chassis number and color code sign, model 1970



Chassis number as from model 1971

GENERAL DATA

	<u>Model 1970-1972</u>	<u>As from model 1973-</u>
Overall length, incl. bumpers	12 ft. 7.5 in. (3,900 mm)	13 ft. 4.4 in. (4,065 mm)
Overall width	4 ft. 11 in. (1,500 mm)	
Overall height, empty	3 ft. 11 in. (1,190 mm)	
Road clearance, fully load	4.9 in. (125 mm)	
Track, front and rear	4 ft. 0.5 in. (1,232 mm)	
Wheelbase	7 ft. 10.6 in. (2,149 mm)	
Turning radius	13 ft. 0.5 in. (4,7 m)	
Curb weight		
without air conditioning	1805 lb (820 kg)	1875 lb (850 kg)
with air conditioning	1875 lb (850 kg)	1945 lb (880 kg)
Gross vehicle weight rating	2330 lb (1055 kg)	2400 lb (1085 kg)
Gross axle weight rating		
front axle	1440 lb (650 kg)	
rear axle	1220 lb (550 kg)	
Vehicle capacity weight	455 lb (205 kg)	
Weight distribution by gross vehicle weight rating	front 55-57 %	
Weight distribution by curb weight	front 61-64 %	
Max. roof load	55 lbs. (25 kg)	
Max. trailer weight	1,100 lbs. (500 kg)	
Hill-climbing performance at curb weight incl. driver:		
2nd gear	39 %	
3rd gear	21 %	
4th gear	12 %	

ENGINE

General data

	Model 1970	As from model 1971
Engine, type V4	4-stroke, 4 cylinders	
Power DIN at 4700 rev/min	48 kW (65 hp)	
Max. torque at 2500 rev/min (DIN)	115 Nm (85 ft.lb., 11.7 kpm)	
Compression ratio, nominal	9.0:1	8.0:1
Number of cylinders	4	
Cylinder bore	3.54 in. (90 mm)	
Stroke	2.32 in. (58.86 mm)	2.63 in. (66.8 mm)
Cylinder volume	91.4 cu.in. (1498 cm ³)	104 cu.in. (1698 cm ³)
Firing order	1-3-4-2	
Placement of cylinders (from front of car):		
Right hand side	1-2	
Left hand side	3-4	
Idling speed	900 rev/min	
Engine suspension	3-point suspension	
Weight, incl. electr. equipment and carburetor	265 lb. (120 kg)	

Cylinder block

Type	60° Vee formation, block and crankcase casted in one piece
Material	Cast iron of a special alloy
Number of main bearings	3
Cylinder block bores for camshaft bushings	front 44.65-44.68 mm center 44.27-44.30 mm rear 43.89-43.92 mm
Cylinder block bores for balance shaft bushings	front 54.420-54.445 mm rear 57.620-57.645 mm
Cylinder bore:	
Standard	90.030-90.040 mm
Oversize 0.02 in. (0.5 mm)	90.530-90.540 mm
Oversize 0.04 in. (1.0 mm)	91.030-91.040 mm
Diameter main bearing bore	red 60.62-60.63 mm blue 60.63-60.64 mm
Thrust bearing width	22.61-22.66 mm

Pistons

Material	Aluminium
Number of piston rings, on each piston	2 compression and 1 oil control ring (tripartite)
Permissible difference in weight (piston and connecting rod) in one and the same engine	0.46 oz. (13 g)
Piston-ring groove width	upper 2.030-2.055 mm center 3.030-3.050 mm lower 4.000-4.020 mm
Piston diameter:	
(The piston is out-of-round and spherical)	standard 89.978-90.002 mm oversize 0.5 90.478-90.502 mm oversize 1.0 90.978-91.002 mm

Piston clearance 0.0011—0.0024 in. (0.03—0.06 mm)
 Piston, removal From the upper side of the cylinder block
 Position of the piston The jag to be turned forward
 Piston and connecting rod must not be separated. Therefore, only piston with connecting rod mounted is available as a spare part.

Piston rings

 Upper compression ring (chrome plated)

 Lower compression ring

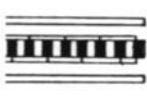
 Segment
 Center spring } Oil control ring
 Segment

S 1267

Upper compression ring:

Thickness	1.978—1.990 mm
Width	0.15 in. max. (max. 3.76 mm)
Piston-ring clearance in groove	0.0394—0.077 mm
Gap in position	0.250—0.500 mm

Lower compression ring:

Thickness	2.978—2.990 mm
Width	0.15 in. max. (max. 3.76 mm)
Piston-ring play (in groove)	0.040—0.078 mm
Gap in position	0.250—0.500 mm

Oil control ring (tripartite):

Thickness (total)	3.824—3.974 mm
Width (segment)	3.430—3.580 mm
Piston-ring play in groove (total)	0.026—0.196 mm
Gap in position (segment)	0.380—1.400 mm

Connecting rods

Bore diameter in the big-end red 56.820—56.830 mm
 blue 56.830—56.840 mm

Vertical inner diameter of fitted con. rod

bearing inserts standard blue 54.004—54.034 mm
 red 54.014—54.044 mm
 undersize 0.25 53.760—53.800 mm
 0.50 53.506—53.546 mm
 0.75 53.252—53.292 mm
 1.00 52.998—53.038 mm

Diameter of crank pins standard blue 53.99—53.98 mm
 red 54.00—53.99 mm
 undersize 0.25 53.476—53.736 mm
 0.50 53.492—53.482 mm
 0.75 53.238—53.228 mm
 1.00 52.984—52.974 mm

Journal clearance in main bearing standard 0.014—0.054 mm
 undersize 0.014—0.064 mm

Crankshaft

Crank pin diameter	see above
Number of main bearings	3
Diameter of main bearing pins	standard red 57.000–56.990 mm blue 56.990–56.980 mm undersize 0.25 56.746–56.736 mm 0.50 56.492–56.482 mm 0.75 56.238–56.228 mm 1.00 55.984–55.974 mm
Vertical inner diameter of fitted main bearing inserts	standard blue 57.004–57.020 mm red 57.014–57.030 mm undersize 0.25 56.760–56.776 mm 0.50 56.506–56.522 mm 0.75 56.252–56.268 mm 1.00 55.998–56.014 mm
Clearance between insert and crank pin	standard 0.012–0.048 mm undersize 0.014–0.058 mm
Thrust journal length (center main bearing)	26.44–26.39 mm
Crankshaft end play	0.102–0.203 mm
Thrust (axial) bearing insert width	26.29–26.24 mm

Balance shaft

Number of bearings	2
Clearance in bushing	front 0.02–0.08 mm rear 0.03–0.07 mm
Balance shaft end float	0.05–0.15 mm
Inner diameter of bushings	front 50.85–50.88 mm rear 54.03–54.05 mm
Bearing diameter of balance shaft	front 50.83–50.80 mm rear 54.00–53.98 mm
Backlash, new drive gear	0.05–0.14 mm
Backlash, wearing limit	0.40 mm

Camshaft

Number of bearings	3
Insert diameter	front 41.516–41.542 mm center 41.135–41.161 mm rear 40.754–40.780 mm
Bearing clearance	all 0.077–0.0025 mm
Inner diameter of bushings	front 41.587–41.593 mm center 41.186–41.212 mm rear 40.805–40.831 mm
Camshaft end float	0.025–0.076 mm
Spacer thickness	red 4.064–4.089 mm blue 4.089–4.114 mm
Camshaft drive	gear pinion
Number of teeth on pinion	34
Number of teeth on camshaft gear	68
Backlash, new drive gear	0.05–0.20 mm
Backlash, wearing limit	0.40 mm
Cam lift	0.256 in. (6.490 mm)
Cam heel-to-toe dimension	34.201–33.998 mm

Valve mechanism

Angle of seat (cylinder head):		45°
Intake and exhaust		
Seat width:		
Intake and exhaust	0.059–0.070 in. (1.5–1.7 mm)	
Stem diameter:		
Intake	standard 8.043–8.025 mm	
	oversize 8.243–8.225 mm	
	8.443–8.425 mm	
	8.643–8.625 mm	
	8.843–8.825 mm	
Exhaust	standard 8.017–7.999 mm	
	oversize 8.217–8.199 mm	
	8.417–8.399 mm	
	8.617–8.599 mm	
	8.817–8.799 mm	
Stem bore in cylinder head:		
Intake and exhaust	8.063–8.088 mm	
Clearance between stem and guide:		
Intake	0.020–0.063 mm	
Exhaust	0.046–0.089 mm	
Disc diameter:		
Intake	1.46 in. (37 mm)	
Exhaust	1.26 in. (32 mm)	
Valve lift	0.38 in. (9.7 mm)	
Valve clearance, cold engine:		
Intake	0.014 in. (0.35 mm)	
Exhaust	0.016 in. (0.40 mm)	
Free length of springs	1.85 in. (47 mm)	
Fully compressed	1.06 in. (27 mm)	
Load for compression to 1.59 in. (40.26 mm)	270–300 N (59–66 lbs., 27–30 kp)	
Valve tappet diameter	22.202–22.190 mm	
Clearance between tappet and bore	0.023–0.060 mm	

Valve timing

Intake opens	21° BTDC	} measured at a valve play of 0.425 mm
Intake shuts	82° ATDC	
Exhaust opens	63° BTDC	
Exhaust shuts	40° ATDC	

Lubrication system

Type	Circulation system lubrication under pressure
Pressure lubricated bearings	Oil pump of rotor type Camshaft, crankshaft, balance shaft, connecting rods, rocker arms
Splash lubrication	Piston pins and cylinder walls
Transmission gear, lubrication	Oil spraying
Oil filter	Full-flow type
Crankcase ventilation, totally enclosed	From air filter via crankcase and NOVO-valve to inlet manifold

Oil according to Ford specification	ESE-M2C-101C or API Service SE
Grade of oil:	
Hot weather	SAE 10 W 40
Normal weather	SAE 10 W 40
	alt. SAE 10 W 30
Cold weather	SAE 5 W 20
	(if constantly below 0°F/-18°C).
Oil pan capacity incl. oil filter	3.3 US quarts (3.3 liters)
Oil pan capacity excl. oil filter	3.0 US quarts (3.0 liters)
Oil pump relief valve opens at	47.0-55.5 lb./sq.in. (3.3-3.9 bar, kp/cm ²)
Oil pressure warning light operates at	4.3-8.5 lb./sq.in. (0.3-0.6 bar, kp/cm ²)
Draining plug, thread	M 14 x 1.5
Oil pump:	
Clearance, rotor to housing	0.012 in. (0.3 mm)
Clearance, rotor to sealing surface	0.004 in. (0.1 mm)

Wrench torques

Bolt joints	Nm	kpm	ft.-lb.
Spark plug	29-39	3-4	22-29
Main bearing cap bolts	98	10,0	72
Connecting rod nuts	34	3,5	25
Crankshaft gear bolt	49	5,0	36
Flywheel retaining bolts, crankshaft	69	7,0	50
Camshaft thrust plate, block	20	2,0	15
Bolt - camshaft gear	49	5,0	36
Cylinder head to block (to be tightened in 3 stages)	54 69 93	5,5 7,0 9,5	40 50 68
Induction manifold to block (to be tightened in 2 stages)	Stage 1 Bolts " 2 "	3,9-7,9 2,1-2,5	2,9-5,8 15-18
	Stage 1 Nuts " 2 "	3,9-7,9 2,1-2,5	2,9-5,8 15-18
Intermediate plate to block	20	2,0	15
Transmission cover	20	2,0	15
Water pump to transmission cover	10	1,0	7
Pulley to balance shaft	49	5,0	36
Oil pump to block	15	1,5	11
Oil pan to block	4,9	0,5	4
Thermostat housing to induction manifold	20	2,0	15
Valve cover to cylinder head	4,9	0,5	4
Rocker shaft bracket	61	6,2	45
Oil filter half a turn after contact between gasket and engine block			

Fuel system

	<u>Model 1970</u>	<u>Model 1971</u>	<u>Model 1972</u>	<u>As from model 1973</u>
Carburetor				
Make	FoMoCo (Auto-Lite)			
Type	70 TW-9510-AA 71 TW-9510-LA 72TF-9510-KEA 73TF-9510-KEA			
Choke	Automatic			
Main jet	150	140	140	140
Float valve	2.0			
Idling speed	900 rev/min			
Rapid idling speed with headlights lower beam on, third step	1900-2100 rev/min			
Float level, fully closed float valve	1.080 ± 0.010 in. (27.5 ± 0.25 mm)			
Float level, fully open float valve	1.420 ± 0.010 in. (36 ± 0.25 mm)			

Fuel pump

Type	Membrane pump driven by eccentric on the camshaft
Feeding pressure	3.4-4.3 lb./sq.in. (0.24-0.30 bar, kp/cm ²) at 4000 crankshaft rev/min
Fuel tank, capacity	15.8 US gal. (60 liters)
Fuel level transmitter	VDO K 221. 87/3/3 alt. K 221. 826/2/6

Exhaust system

Exhaust pipe, internal diameter	1.34 in. (34 mm)
---------------------------------	------------------

Cooling system

	<u>Model 1970</u>	<u>As from model 1971</u>
Type	Overpressure	
Capacity, incl. heater	1.8 US gal. (7.0 liters)	
Thermostat opening range	181°F (83°C)	
Max. opening	0.28 in. (7 mm)	
Radiator pressure cap opens at	3.5-4.2 lb./sq.in. (0.25-0.30 bar, kp/cm ²)	7.5-10.3 lb./sq.in. (0.55-0.75 bar, kp/cm ²)

Freezing points for glycol mixtures

Volume % glycol	Freezing Point	
	°F	°C
10	25	-4
20	14	-10
30	1	-17
40	-15	-26
50	-38	-39

ELECTRICAL SYSTEM

Battery

Voltage	12 V
Capacity	44 Ah

Alternator

Type	Bosch K1 ←→ 14 V 35 A 20	0 120 400 657
Rated voltage		14 V
Rated rev/min		2000
Max. permissible continuous load		35 A
Direction of rotation	Clockwise and counter-clockwise	
Brush-spring pressure	2,9–3,9 N (10.5–14 oz., 300–400 p)	
Ratio engine-alternator		1:1.85
Testing values, see group 3.		

Charging regulator

Type designation	Bosch AD 1 14 V	0 190 601 006
	(not radio suppressed)	

Starter

Type designation	Bosch GF 12V 1,0 PS	0 001 311 023
Number of teeth on pinion		9
Number of teeth on ring gear		138
Output		0,7 kW (1,0 hp)

Testing values

Mechanic values:

Brush-spring pressure	11.3–12.8 N (40.5–46 oz., 1150–1300 p)
Pinion backlash	0.0138–0.0236 in. (0.35–0.6 mm)
Distance between pinion and ring gear	0.0985–0.118 in. (2.5–3.0 mm)
Contact reserve	0.0395 in. (1.0 mm)
Rotor axial clearance	0.00197–0.0118 in. (0.05–0.3 mm)
Rotor brake friction torque	0.25–0.40 Nm (0.181–0.290 ft. lbs., 2.5–4.0 kpcm)
Pinion clearance torque	0.13–0.18 Nm (0.094–0.130 ft. lbs., 1.3–1.8 kpcm)

Electric values:

Idle speed	11.5V and 35–55A 6500–8500 rev/min
Charged	9V and 205–235A 1000–1300 rev/min
Locked starter motor	6V 325–375A
Lowest pull-in voltage for operating solenoid switch	8V

Distributor

	<u>Model 1970</u>	<u>As from model 1971</u>
Type	Bosch JFUR 4	
Type designation	0 231 146 084 and 0 231 146 092	0 231 167 039
Capacitor	1 237 330 185	1 237 330 196
Capacity	0,2 μ F \pm 10%	0,2 μ F \pm 10%
Vacuum chamber	1 237 121 335	1 237 121 849
Ignition setting:		
Basic setting with stroboscope at max. 800 rev/min with disconnected vacuum hose	6° B.T.D.C.	3° B.T.D.C. at max. 800 rev/min and both vacuum hoses disconnected

Remark! 1° on the balance shaft pulley corresponds to approx. 0.05 in. (1.2 mm) on the circumference of the pulley.

Order of firing, cyl. 1 is the furthest R.H. one	1-3-4-2
Breaker gap	0.016 in. (0.4 mm)
Dwell angle	50 \pm 2°
Contact pressure	4.9-6.2 N (18-22 oz., 500-630 p)
Direction of rotation	Clockwise
Resistance in breaker arm	3000 ohms \pm 20%

NOTE! Ignition advance curves, see group 3.

Ignition coil

Type designation	Bosch K 12
Performances at a primary voltage of 12 V:	
4.000 sparks/minute (1.000 distributor revolutions). Spark length min.	0.55 in. (14 mm)
16.000 sparks/minute (4.000 distributor revolutions). Spark length min.	0.24 in. (6 mm)
Primary-winding resistance (between connections 1 and 15)	3.1-3.6 ohms

Spark plugs

	<u>Model 1970</u>	<u>Model 1971-1972</u>	<u>As from model 1973</u> (Approx.)
Thread	M 14 x 1.25		
Electrode gap	0.024-0.028 in. (0.6-0.7 mm)		0.025 in. (0.6 mm)
Motorcraft	AG 22	AG 32	AGR 32 (Resistor)
Bosch	W 200 T 30 or W 230 T 30	W 145 T 30	
Champion	N-9Y or N-6Y	N-11Y	RN-11Y
NGK	BP 7 E	BP 6 E	
Tightening torque	29-39 Nm (22-29 ft.-lb., 3.0-4.0 kpm)		
Resistance in spark plug connections	1000 ohms \pm 10%		

Bulbs

	Effect	US No.	Qty.
Headlight (Sealed Beam)	50/45 W	6012	2
Parking light, front and direction indicator light, front	4/32 cp (5/21 W)	1034	2
Side position light, front and rear	2 W	57	4
Rear direction indicator, stop lights and back-up lights	21 W	1073	6
Tail light and number plate light	5 W	67	4
Control- and instrument lamps	1,2 W	Miniature bulb	11 (As from model 1973: 13)
Courtesy light	4 cp (5 W)	Cartridge bulb	1
Control lamp, hazard warning signal	2 W	Miniature bulb	1
Tachometer light	2 W	Miniature bulb	1
Seat belt warning light	1.2 W	Miniature bulb	1

Fuses

16 fuses, 1 in. (25 mm) 8 amp.

Flasher unit

Type designation:

Hella	91/1 P3 V2X 21W-12V
Tungsol	550 12 V
Flashing frequency	60-120 impulses/min

Horn

Type designation	Hella B 31/35 12 V H
	B 31/35 12 V T

Heater fan motor

Type designation	Up to chassis No. 71501200		As from chassis No. 71501201	
	Elektrolux KS 4030/100		Elektrolux 4030/101	
Output and speed at free blowing and a voltage of 13V:	<u>rev/min ± 5%</u>	<u>W ± 5%</u>	<u>rev/min ± 200</u>	<u>W ± 5%</u>
1/2-speed	2400	60	2400	56
1/1-speed	3000	80	3700	96
high speed	3950	125	—	—

Windshield wiper motor

Type designation	<u>Model 1970</u> Lucas DL 3 A	<u>As from model 1971</u> Lucas 16 W 25042
------------------	-----------------------------------	---

Windshield washer

Type designation	MEAB (SCHÜRER)
------------------	----------------

Transmission

Oil capacity	approx. 1.7 US quarts (approx. 1.7 liters)
--------------	---

Type of oil	EP-oil SAE 80
-------------	---------------

Gear ratios, total:

1st gear	16.2:1
2nd gear	9.7:1
3rd gear	6.0:1
4th gear	3.9:1
Reverse	14.8:1
Differential gear ratio, pinion: ring gear	4.66:1
Number of teeth, pinion: ring gear	9:42

Road speed in mph at 1000 rev/min
engine speed, calculated running
radius 11.8 in. (300 mm):

1st gear	4.3 mph (7.0 km/h)
2nd gear	7.3 mph (11.7 km/h)
3rd gear	11.9 mph (19.0 km/h)
4th gear	18.1 mph (29.0 km/h)
Reverse	4.7 mph (7.6 km/h)

Pinion/ring-gear adjustment:

Specified dimension ± 0.002 in. (0.05 mm)

Ring-gear backlash:

Specified dimension ± 0.002 in. (0.05 mm)

Matched gear sets

- { 3rd speed gear
- { Pinion shaft 3rd gear
- { 4th speed gear
- { Pinion shaft 4th gear
- { Ring gear
- { Pinion shaft
- Synchromesh

Tightening torques, gear box

Bolt joints	Bolts		Tightening torques		
	Quant.	Size	Nm	kpm	ft.lb.
Transmission case end cover	6	5/16"	25	2.5	18
Differential bearings	4	3/8"	39	4	29
Ring gear bolts	12	5/16"	25	2.5	18
Pinion-shaft nut. First tightening	1	7/8"	118	12	87
Then slacken and re-tighten			59	6	44
Nut, primary shaft	1	3/4"	49	5	36
Nut, countershaft	1	3/4"	79	8	60

Clutch

Make	Fichtel & Sachs
Type designation	X 190 K
Type	Single dry plate
Clearance, release bearing — clutch measured at the slave cylinder	0.16 in. (4 mm)
Clearance between release plate and flywheel	approx. 1.0 in. (26 mm)
Pressure-plate springs:	
Length compressed	0.96 in. (24.5 mm)
Tension when compressed	600–660 N (134–147 lb, 61–67 kp)
Dimensions of clutch facing	5 x 6.5 in. (127 x 190.5 mm)

New clutch disc:	
Thickness, unloaded	0.33 ± 0.04 in. (8.4 ± 0.1 mm)
Thickness, loaded with 3680 N (825 lbs., 375 kp)	0.28 ± 0.01 in. (7.2 ± 0.3 mm)
Max. throw clutch disc	0.024 in. (0.6 mm)
Engagement pressure	3340–4170 N (750–935 lb., 340–425 kp)

Clutch operation, hydraulic

	Master cylinder	Slave cylinder
Make and type	Girling 5/8"	Girling 3/4"
Cylinder diameter	5/8"	3/4"
Max. permissible stroke	1.38 in. (35 mm)	
Hose connection	3/8" UNF-24	7/16" 20 UNF-2B
Hose length between mas- ter and slave cylinder		14 in. (355 mm)
Distance from clutch-pedal foot plate to toe-board (max. pedal stroke)		approx. 3.55 in. (ca 90 mm)
Clearance, release bearing – clutch measured at the slave cylinder		0.16 in. (4 mm)

BRAKE SYSTEM

General

Make	Lockheed
Type front	Disc brake
Type rear	Drum brake
Footbrake	Hydraulic twocircuit type
Handbrake	Mechanical
Brake fluid	Quality corresponding to the labeling required by Federal Motor Vehicle Standard 116; i.e., DOT 3 or DOT 4

Dimensions

Brake disc:	
Diameter	10 1/2" (266.7 mm)
Thickness	0.374" (9.5 mm)
Grinding permitted to min. thickness (Note! Max. grinding 0.10" per side, 0.25 mm per side.)	0.355" (9.0 mm)
Max. total indicated axial throw	0.08 in. (0.2 mm)
Brake drum:	
Diameter	8" (203.2 mm)
Adjustment machining permitted to max. diameter	8.06 in. (204.7 mm)
Max. total indicated radial throw	0.006 in. (0.15 mm)
Brake shoes	8 x 1 1/2"
Offcenter grinding of brake linings:	
Radius of brake lining	0.020–0.022 in., (0.50–0.56 mm) less than that of the drum

Master cylinder:	
Diameter of cylinder	3/4"
Clearance between master-cylinder piston and push-rod	0.024–0.047 in. (0.6–1.2 mm)
Same clearance at tip of brake pedal	0.12–0.24 in. (3–6 mm)
Distance from brake-pedal foot plate to the lower part of the dash panel (max. stroke)	approx. 3.5 in. (approx. 90 mm)
Wheel cylinder, front	2"
Wheel cylinder, rear	5/8"
Brake lines	3/16" Bundy tube
Brake hoses, front and rear, length	8 1/2"
Tightening torques:	
Castle nut, front wheel hub	177 Nm (18 kpm, 130 ft.lb.)
Castle nut, rear wheel hub	88 Nm (9 kpm, 65 ft.lb.)

FRONT ASSEMBLY, STEERING

Wheel alignment

Front wheel alignment, no load:

"King-pin" inclination	7 ± 1°
Caster	2 ± 1/2°
Camber	0 ± 1/4°
Toe-in at wheel rim	0.04 ± 0.04 in. (1 ± 1 mm)
Turning angles:	
Outside wheels	20°
Inside wheels	22 1/2 ± 1 1/2°

Steering gear:

Steering gear adjustment:

Pinion axial clearance	max. 0.005 in. (0.12 mm)
Radial clearance of rack	max. 0.01 in. (0.25 mm)
Steering ratio, steering wheel/road wheels average	15.5:1
Wheel travel between limit positions	2.7 turns

Tie rod ends:

Distance between end of thread and lock nut	max. 1.0 in. (25 mm)
Permissible difference between left hand and right hand dimension	max. 0.08 in. (2 mm)

Tightening torque:

Nut, tie-rod end	34–49 Nm (3.5–5 kpm, 25–36 ft.lb.)
------------------	------------------------------------

Rear wheel alignment:

Camber	0 ± 1°
Toe-in (toe-out)	0 ± 1°
Both wheels together or measured rim-to-rim	0 ± 0,28 in. (7 mm)
Toe-in (toe-out) per wheel must not exceed	0 ± 3/4°
Max. difference in wheelbase, left and right (front wheels pointing straight ahead)	0.6 in. (15 mm)

Front shock absorbers:
 Type of shock absorber Telescopic, hydraulic
 Length of front shock absorber 9 3/4 in. (250 mm)
 Extended 15 3/8 in. (390 mm)
 Front shock absorber stroke, fitted 3 1/4 in. (82 mm)

Rear shock absorbers:
 Type of shock absorber Telescopic, hydraulic
 Length of rear shock absorber between centre hole and shoulder for washer 10" (255 mm)
 Extended 16 7/16" (417 mm)
 Stroke, shock absorbers 4 1/4 in. (106 mm)

Wheels

Type "wide base"
 Size 4.5 J x 15"
 or 4.5 JFHA x 15"
 Depth of drop center 1.77 in. (45 mm)
 Permissible out-of-round of rim, see fig. A 0.06 in. (1.5 mm)
 Permissible rim throw, see fig. B 0.06 in. (1.5 mm)



MEASURE POINTS ON THE RIM

Tires

Size 155 SR x 15"
 Tire pressure:
 Front 25 psi. (1.8 bar, kp/cm²)
 Rear 22 psi. (1.6 bar, kp/cm²)

SUSPENSION, WHEELS

Front coil spring
 Max. spring expansion, front 5 1/2 in. (139 mm)
 Front coil springs, length 13.4 in. (339 mm)
 Front coil springs, number of coils springing 8 1/2
 Wire diameter 0.47 in. (12 mm)
 Rear coil spring
 Max. spring expansion 5.9 in. (150 mm)
 Rear coil springs, length 12.5 in. (318 mm)
 Number of coils springing 7 1/2
 Wire diameter 0.4 in. (10.0 mm)

Wheel bolts
 Width across flats 3/4 in. (19.05 mm)
 Thread UNC 9/16"

Tightening torques
 Castle nut, front wheel hub 177 Nm (18 kpm, 130 ft.lb.)
 Castle nut, rear wheel hub 88 Nm (9.0 kpm, 65 ft.lb.)
 Wheel bolts 79-98 Nm (8-10 kpm, 58-72 ft.lb.)

Body

Enamel:	Colour code	Colour	Manufacture
	Ser 107 No. 1111	Yellow	Sadolin & Holmblad
	Ser 107 No. 1116	Red	Sadolin & Holmblad
	Ser 107 No. 1117	Green	Sadolin & Holmblad
	Ser 107 No. 1119	Blue	Sadolin & Holmblad
	56197 - 3044	Orange	Nordsjö (up to and incl. model 1972)
	56197 - 3045	Yellow	Nordsjö (- " -)
	56197 - 4022	Red	Nordsjö (- " -)
	56197 - 6016	Green	Nordsjö (- " -)
	56191 - 3044	Orange	Nordsjö (as from model 1973)
	56191 - 3045	Yellow	Nordsjö (- " -)
	56191 - 4022	Red	Nordsjö (- " -)
	56191 - 6016	Green	Nordsjö (- " -)
	TH 113 - 3001	Blue	Beckers
	U-POX 100 - 1276	Matblack (rear part)	Sadolin & Holmblad
	TH 113-2001	Burgundy-red	Beckers
	56191-6022	Green	Nordsjö
	TH 113-1005	Yellow	Beckers (as from model 1974)
	TH 113-2002	Orange	Beckers (-"-)
	TH 113-2003	Red	Beckers (-"-)
	TH 113-3004	Blue	Beckers (-"-)
	TH 113-4006	Green	Beckers (-"-)

INSTRUMENTS

Speedometer drive ratio
 Ratio ring gear: pinion 9:42
 Dynamic radius of road wheel 11.8 in. (300 mm)
 Speedometer:
 Rev. per kilometer covered 570
 Rev. per mile covered 917

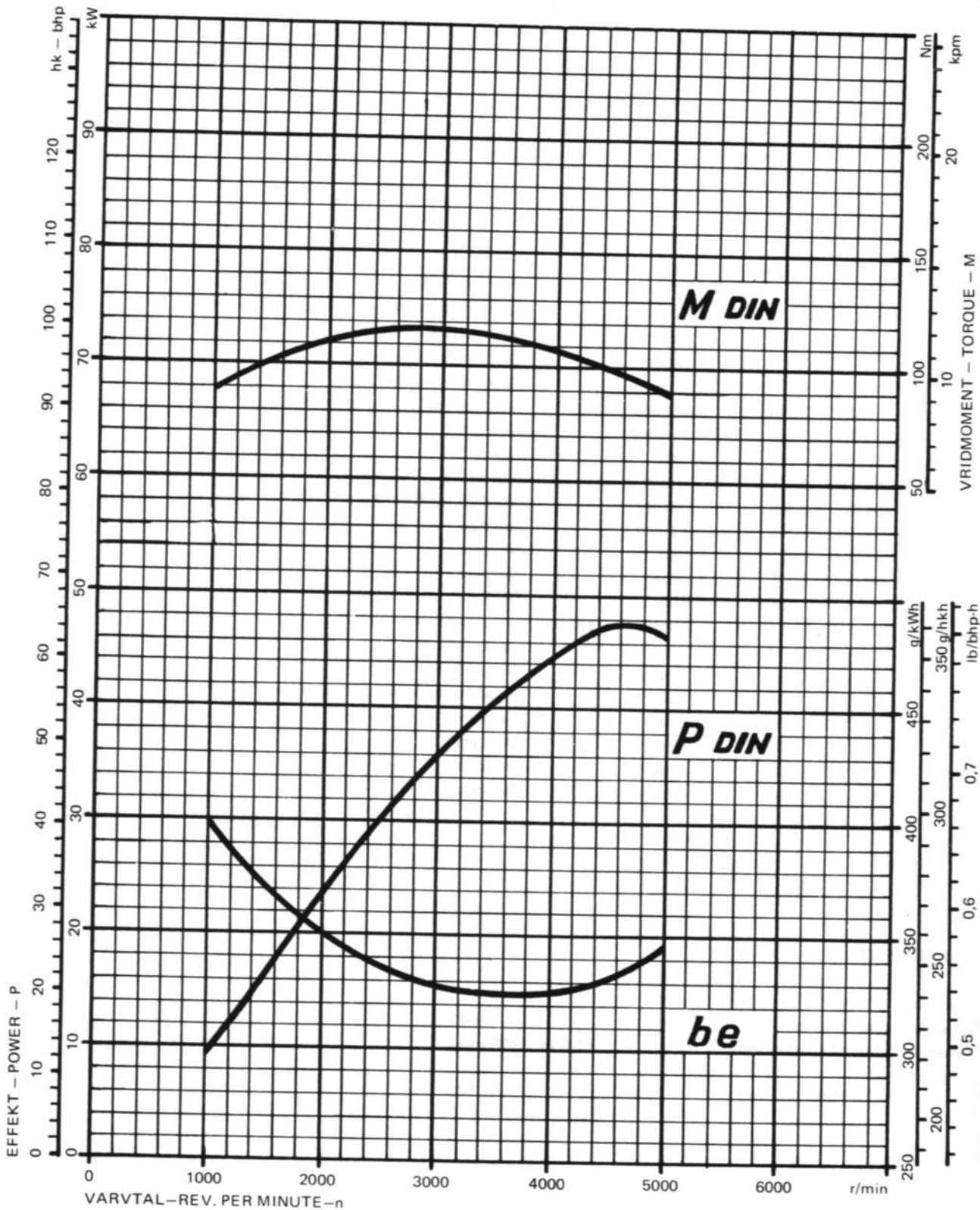

S 3849

VRIDMOMENT - TORQUE - M

SPEC. BRÄNSLEFÖRBRUKN - SPEC. FUEL CONSUMPTION - be

ENGINE PERFORMANCE CURVES SAAB SONETT

- P = output
- M = torque
- be = spec. fuel consumption

CONTENTS

100	General hints
101	Special tools*)
102	Various tools*)
	Service inspections
110	General*)
120	Lubrication
130	Washing and polishing*)
141	Underbody- and rustpreventing treatment*)

*) See Service Manual Saab V4.

0

0

0

0

GENERAL HINTS

General

All shop personnel will be aware of the importance of tidiness and good order in the shop; similarly, every experienced mechanic realizes that certain parts of a car must be treated with care and protected from dirt and foreign matter while being serviced. For the new man, who may not be so familiar with the kind of work involved, the following hints may be of help:

1. Protect fenders and other painted areas with suitable covers while working with the car. It is easy to get grease stains or scratches on the paintwork, but it is far more difficult to remove them.
2. Protect the upholstery from oil, etc., by using protective covers.
3. Clean the car thoroughly under fenders and around the rear axle before starting work on hubs and axles. Apart from making work easier, this prevents dirt and grit from getting into bearings and other susceptible parts.
4. Before removing a spark plug, carefully clean the recess around its head.
5. One of the basic prerequisites of good service is the choice of a suitable place for each job. It would be most unsuitable, for instance, to dismantle an engine or a gearbox on or near a bench used for filing or similar abrasive operations.

Thread system and wrench sizes

The thread system mainly used in the Saab car is the UNC, i.e. UNIFIED COARSE THREADS, in which inches are the unit of measurement.

Wrench sizes for nuts and bolts are expressed in inches and the dimensions are the same as the designations of the tools. In a few cases, UNF, i.e. UNIFIED FINE, threads are used.

An important exception is the engine, which has metric thread system.

Exceptions to the thread system will also be encountered in the case of components supplied by sub-suppliers, such as Bosch, where metric threads will be found.

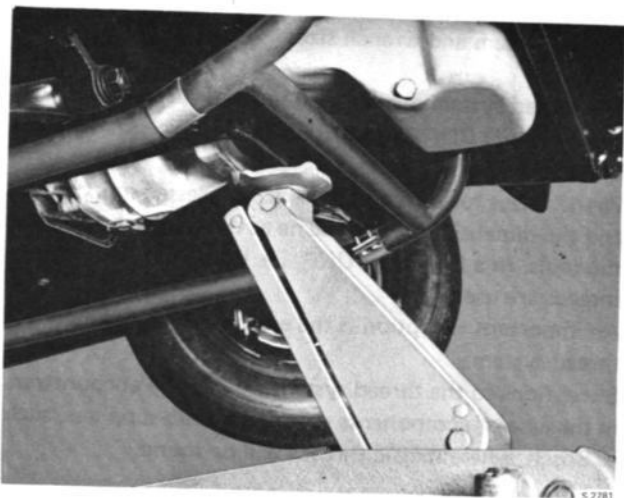

JACKING-UP THE FRONT END



JACKING-UP THE REAR END

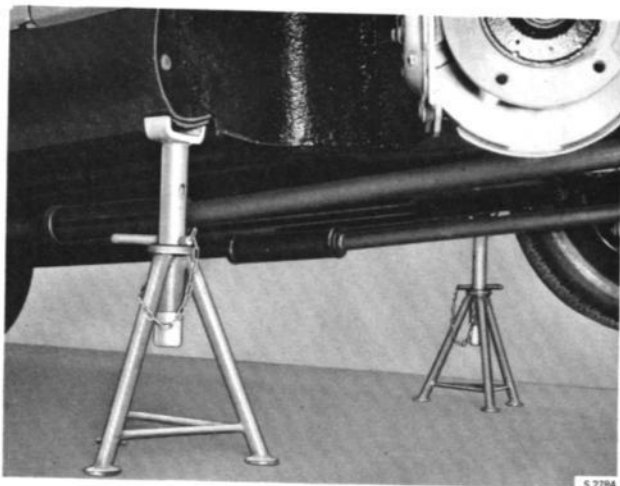

SUPPORTING THE FRONT END ON TRESTLES

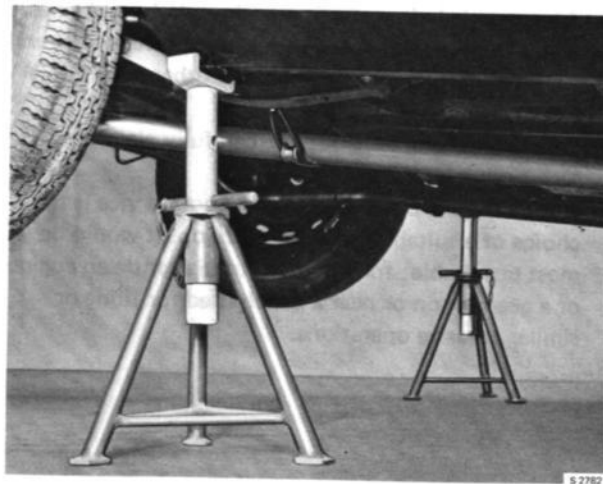

SUPPORTING THE REAR END ON TRESTLES

Instructions for jacking-up the car

Two special fittings are provided on each side, to take the jack included in the tools for the car. They are intended for use when changing wheels, etc. Under the front of the engine compartment floor, immediately behind the exhaust manifold pipe, a welded fitting provides a support for a shop jack. This is the best point at which to lift the front of the car in order to lubricate the ball joints. A similar jacking point is provided under the rear part of the car, where the floor is reinforced. This point is located

on the center line of the car, immediately in front of the rear axle tunnel. Most shop jacks feature a lifting head shaped like a low fork, and it is therefore advisable to place a wooden block of suitable size on this in order to avoid damaging the floor. For lifting of one side of the car, place the shop jack — provided with a wooden block — under one of the sill supports. For certain jobs it is necessary to support the front or rear part of the car on trestles. Most of the stands usually available will be found suitable for the Saab. Make sure that the weight of the car is borne up on the supports at the wheel houses.

LUBRICATION

General

Proper lubrication is vital to good car maintenance and must on no account be neglected. The car should be lubrication serviced at intervals of 6,000 miles (10,000 km) or at least twice a year, subject to the use of Saab Special Chassis Grease and to a strict watch being kept on the condition of rubber boots and seals. Lubrication service is therefore included in the regular service inspections carried out at intervals of 6,000 miles (10,000 km), for which vouchers are provided in the Service Book. As from model 1973, the maintenance program is included in the Owner's Manual.

The intention is for service inspections and lubrication to be carried out at the same time by an approved service shop, thus reducing to a minimum the time during which the owner must do without his car.

NOTE

Always use only Saab Special Chassis Grease for greasing jobs.

It is available as a spare part under reference Saab Special Chassis Grease. The grease is stocked both in a cartridge pack (length 9.33 in. or 237 mm, diameter 2.09 in. or 53 mm) for a manual grease gun and in drums. Various makes of manual grease gun designed to take these grease cartridges are available, e.g. "Tecalemite" model 2840-Ta, with hose 110 B.

If, for some particular reason, Saab Special Chassis Grease is not used, lubrication must be carried out more frequently, i.e. at intervals of 3,000 miles (5,000 km). Saab Special Chassis Grease must not be mixed with ordinary chassis grease, so that either the one or the other must be used.

In some types of lubricating plant, difficulty may be experienced in feeding the grease to the grease pump. In such cases, a feeder lid can be fitted to the drum. Suitable lids are obtainable from suppliers of lubricating equipment.

Cleanliness is a matter of the utmost importance during lubrication work, as it is during all work on the car, and great care must be taken to avoid leaving grease marks on bodywork or upholstery.

WARNING

Caution must be observed when using Saab Special Chassis Grease, as if spilled it may, in some cases, damage the paintwork of the car.

When lubricating the ball joints of the front assembly, the car should be jacked up to lift the wheels off the floor.

Lubrication interval: 6,000 miles (10,000 km) or at least twice a year

1. BALL JOINTS AND TIE ROD ENDS

When lubricating the ball joints, the front of the car should be jacked up to lift the wheels off the floor. (Does not apply to cars with permanently lubricated joints.)

2. STEERING GEAR

Avoid excessive lubrication of the steering gear.

NOTE

While greasing, turn the steering wheel to full left lock so that the grease penetrates also to the right-hand part of the steering gear.

Check that rubber boots are not abnormally swollen after lubrication and that they are free of defects likely to cause loss of grease. Defective parts must be renewed.

3. ACCELERATOR LINKAGE

All bearings belonging to the throttle-control assembly are accessible from inside the engine compartment.

4. BRAKE SYSTEM

The brake-fluid reservoir must always be kept well filled. Check the fluid level once every 3 months and after bleeding the hydraulic system. At the same time, check that the breather holes in the cover are not choked. Always use the grade of brake fluid recommended in the lubrication table.

5. HYDRAULIC CLUTCH OPERATION

The reservoir must always be kept filled with brake fluid up to the mark on the outside of the reservoir. Check the fluid level at least once every three months.

6. PEDALS

The clutch- and brake pedal is lubricated at their respective bearings on the pedal shaft. The accelerator is lubricated at the hinge by which it is fastened to the floor.

7. BREAKER CAM

Grease with Bosch Ft 1 v 4.

8. DISTRIBUTOR, LUBRICATING FELT UNDER DISTRIBUTOR ARM

The felt pad in the upper end of the shaft under the distributor arm (which must be removed first) shall be lubricated sparingly.

NOTE

Avoid excessive lubrication of distributor parts, as grease on the breaker points causes burning of these.

9. GEAR BOX

The gear box and differential are filled and drained through the same openings.

Check the oil level every 6,000 miles (10,000 km) with the dipstick 786244 after unscrewing the filler plug. If a dipstick is not handy, check the oil level after unscrewing the level plug. The level should not be lower than 0.2 in. (5 mm) below the hole for the level plug.

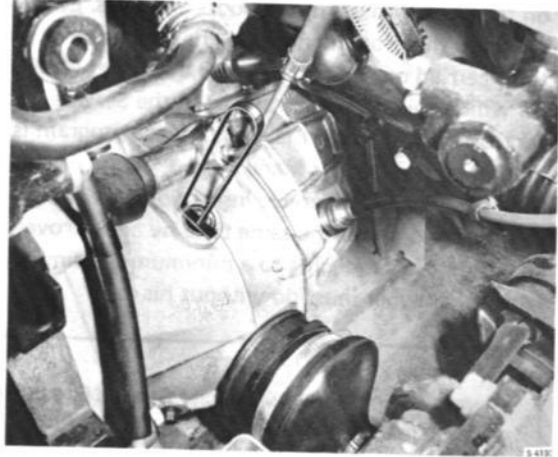

CHECKING THE OIL LEVEL IN THE TRANSMISSION

Change the oil in the gear box for the first time after 1,200 miles (2,000 km), and thereafter at intervals of 12,000 miles (20,000 km) or at least once every year. Use EP oil, SEA 80, all the year round.

ENGINE

Oil according to Service Class SE in the API system or to Ford specification ESE-M2-101C.

Viscosity:

Hot weather SAE 10 W 40

Normal weather SAE 10 W 40 (alternative SAE 10 W 30)

Cold weather SAE 5 W 20 (if constantly below 0°F / -18°C).

Oil quantity 3 US quarts (3 liters) incl. oil filter 3.5 US quarts (3.3 liters). The distance between the upper and lower marks on the dipstick corresponds to a volume of 1.5 US quarts (1.5 liters).

The engine oil is changed the first time at 1,200 miles (2,000 km). Next oil change at 6,000 miles (10,000 km), and then every 6,000 miles (10,000 km). Replace the oil filter every 6,000 miles (10,000 km). Use original filter only.

11. HINGES

Door hinges are provided with special lubrication fittings, comprising a rubber plug with a through hole. To lubricate, press the oil can against the rubber plug.

Lubrication Chart, intervals 6.000 miles (10.000 km) or twice a year

Index	Lubrication points	Number	Lubricant	Instructions
1	Ball joints and tie rod ends ¹⁾	6	Saab Special chassis grease	Grease gun
2	Steering gear	1	Saab Special chassis grease	Grease gun. Steering wheel turned fully to the left.
3	Accelerator linkage	4	SAE 40 oil	Oil can
4	Hydraulic brake system	1	Brake fluid DOT 3 or 4.	Check, intervals of max. 3 months*
5	Hydraulically operated clutch	1	As above	Check, intervals of max. 3 months
6	Pedals	3	SAE 40 oil	Oil can
7	Breaker cam	1	Bosch Ft 1 v 4	Grease
8	Distributor lubr. felt under rotor	1	Motor oil	Oil
9	Gearbox	1	EP oil SAE 80 to specification API-GL-5 (1,8 US quarts = 1.7 liters)	Check every 6.000 miles (10.000 km), change every 12.000 miles (20.000 km)
10	Engine	1	Follow instructions on page 120-2	Oil change Replace oil filter NOTE! Use original filter only.
	Hinges	4	SAE 40 oil	Oil can

*The brake fluid should be changed every 24.000 miles (40.000 km), or at intervals not exceeding 2 years.

¹⁾ Does not apply to cars with permanently lubricated joints.

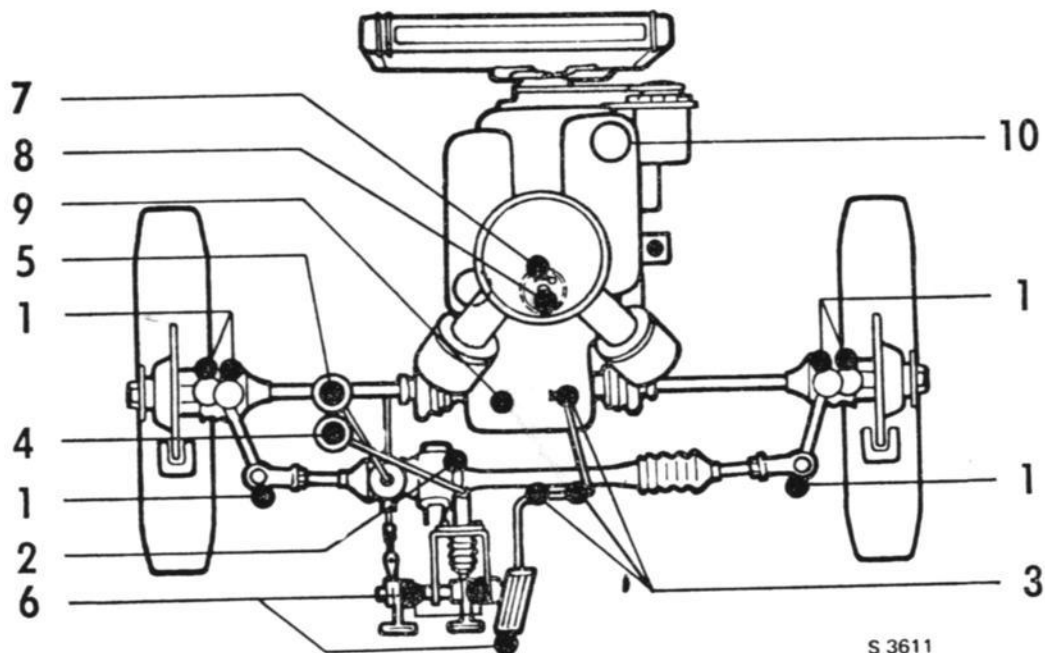

Lubrication points

Numbers refer to the Lubrication Chart

In connection with reconditioning

When reconditioning, repack the following lubrication points with Saab Special Chassis Grease.

Front wheel bearings.

Rear wheel bearings.

Outer shaft universal joint.

Inner shaft universal joint (the joint should be filled).

Other lubrication

Whenever necessary, also lubricate the following.

1. Lubricate the seat rails with chassis grease if stiff.
Wipe off all superfluous grease to avoid staining clothes and upholstery.
2. The locking devices for engine lid, compartment lid, and openable side windows sparingly with vaseline.

Laying up

If the car is to be laid up for any length of time, e.g. during the winter months, it should first be lubrication serviced. To avoid corrosion and other internal damage to the engine, the engine oil should be changed. Also remove the battery and store it at room temperature in well-charged condition.

FUEL

Model 1970:

PREMIUM FUEL

As from model 1971:

REGULAR minimum 91 research octane number. A good grade of regular fuel. Only leaded fuel should be used. The reasons are:

1. Lead acts as a lubricant for the valve seats and prolongs valve life.
2. By preventing deterioration of the valve seats, low emission levels can be maintained through the life of the vehicle.

CONTENTS

200	Description
201	Removal and installation of engine body
	Engine body
210	Disassembly and reassembly*
211	Cylinder head*
214	Valve mechanism*
215	Transmission*
216	Crank mechanism*
217	Oil pan*
	Lubricating system
221	Oil pump*
222	Oil filter*
	Fuel system
231	Carburetor. Deceleration valve*
233	Fuel pump*
234	Fuel tank with fittings and fuel lines
	Inlet and exhaust system
251	Induction manifold*
252	Exhaust system
	Cooling system
261	Radiator with connections
262	Water pump, fan and thermostat*
291	Sundries*

*) See Service Manual Saab V4.

C C

C C

DESCRIPTION

V4 engine

The engine in the Sonett III is identical with the V4 en-

gine installed in the Saab V4, except that it is provided with harder valve springs.

See the Service Manual for Saab V4.

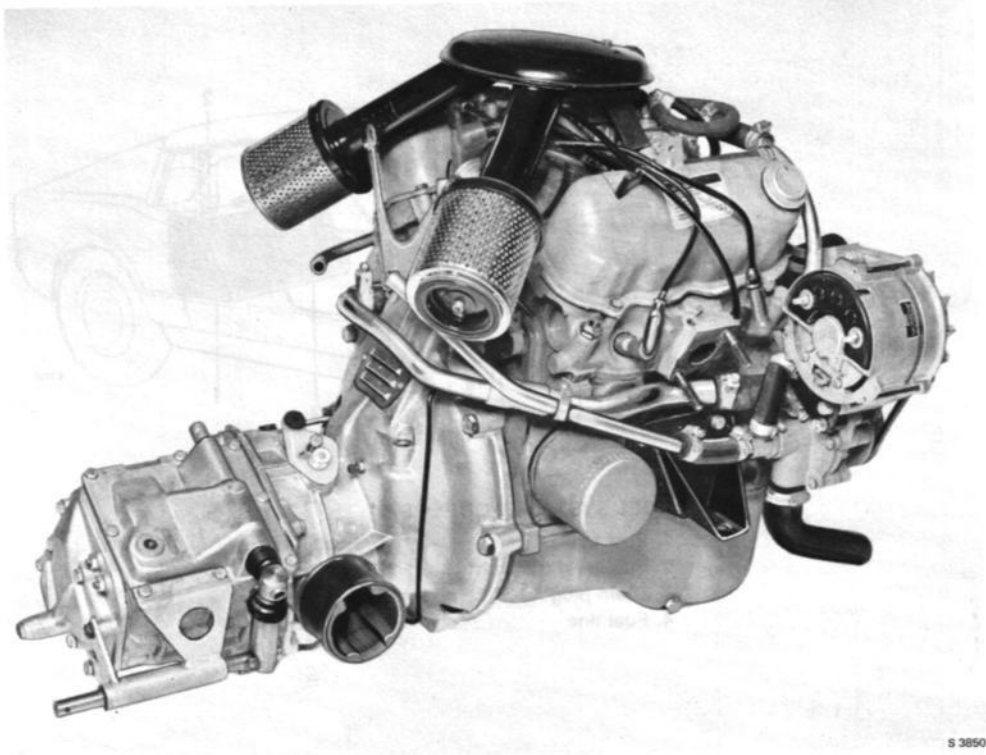

S 3850

ENGINE AND GEARBOX

Fuel system

The fuel tank is located above the rear axle behind the partition between the passenger compartment and the luggage compartment. The fuel tank capacity is 15.8 US gals. (60 lit.).

The tank cap has no ventilation hole. Ventilation takes place via a hose from the filler pipe. This hose runs out under the rear fender (model 1970).

As from model 1971 the fuel system is equipped with an evaporative loss control unit. This unit includes a charcoal canister which is placed in the engine compartment. It absorbs the vapor from the tank when the en-

gine is not running. The charcoal is purged when the engine is running. This is achieved by fresh air which is sucked through the filter in the bottom of the canister and further to the carburetor.

The fuel filter and the canister filter should be renewed at intervals according to the directions given in the Service Book (up to and incl. model 1972). As from model 1973, see maintenance program in the Owner's Manual.

The fuel pump, which is of diaphragm type, pumps the fuel from the tank to the carburetor.

The Sonett III engine features a down-draft carburetor of the FoMoCo make (Auto-Lite). The carburetor is similar to the type fitted in Saab V4 engines, except that it features a bigger main jet.

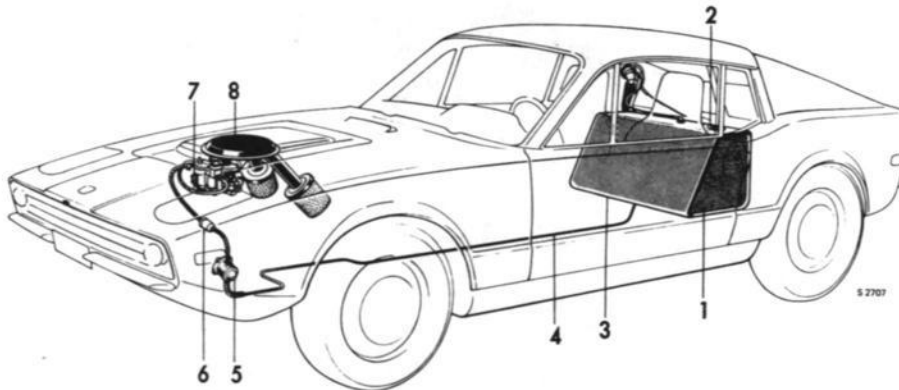

FUEL SYSTEM, MODEL 1970

- | | |
|---------------------------|----------------|
| 1. Fuel tank | 5. Fuel pump |
| 2. Fuel level transmitter | 6. Fuel filter |
| 3. Drain plug | 7. Carburetor |
| 4. Fuel line | 8. Air cleaner |

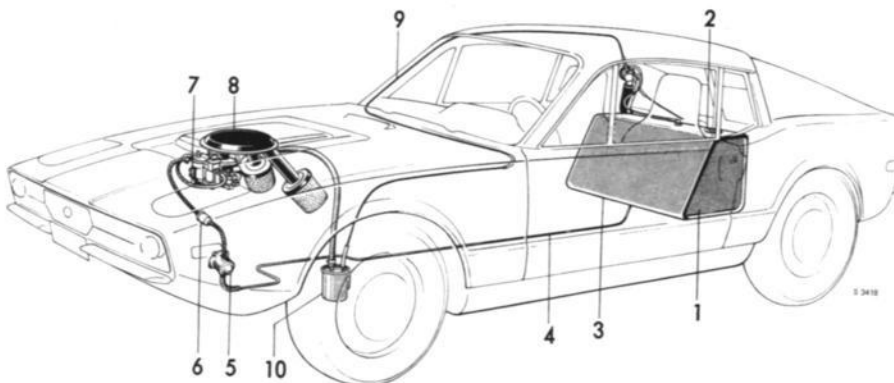

FUEL SYSTEM, AS FROM MODEL 1971

- | | |
|---------------------------|-----------------------|
| 1. Fuel tank | 6. Fuel filter |
| 2. Fuel level transmitter | 7. Carburetor |
| 3. Drain plug | 8. Air cleaner |
| 4. Fuel line | 9. Vapor hose |
| 5. Fuel pump | 10. Charcoal canister |

Fuel tank ventilation

When fuel is poured in, the tank (1) will not be completely filled, and instead the level rises only slightly above the lower opening on the venting tube (3). The reason for this is that an air cushion is formed above this level and prevents further filling of the tank.

The formation of this air cushion is due in its turn to the fact that a spring-loaded valve (5) located in the filler pipe (2) blocks the upper opening on the venting tube (4) from the upper side of the tank.

When the tank cap (7) is screwed on, a lever is actuated which opens the valve, thus providing a communication from the upper part of the tank to the surrounding air via the ventilation hose (6). The fuel, which increases in volume when the temperature rises, is now able to expand inside the tank instead of being pressed up through the filler pipe (2). As the fuel level becomes lower in course of driving, air is drawn into the tank via the ventilation hose (6).

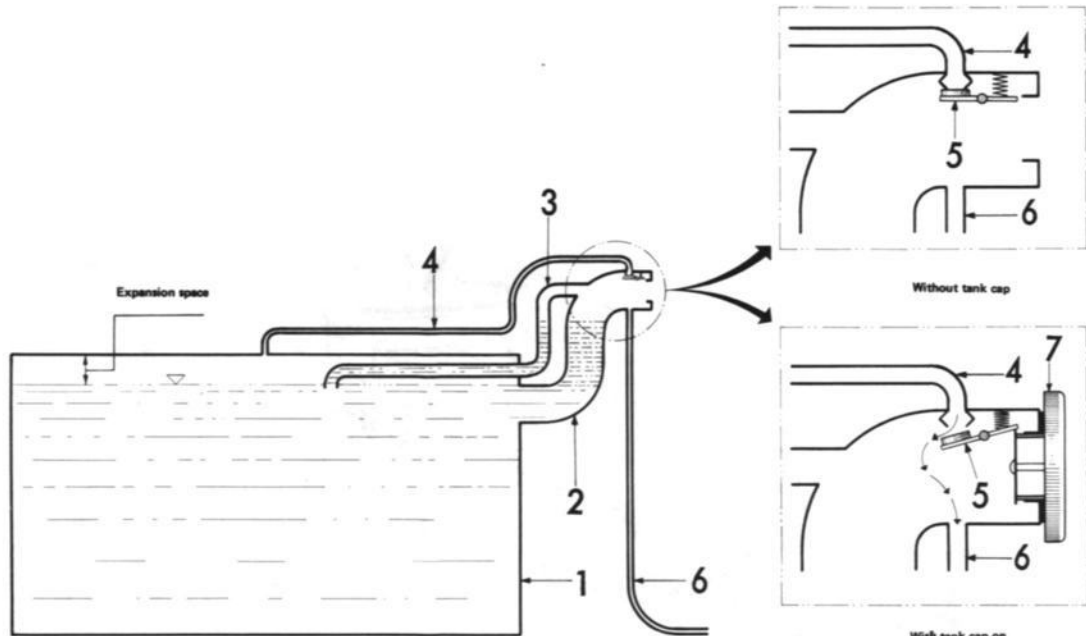

FUEL TANK VENTILATION,
ARRANGEMENT DIAGRAM

1. Fuel tank
2. Filler pipe
3. Venting tube
4. Venting tube
5. Spring-loaded valve
6. Ventilation hose
7. Tank cap

Air cleaner

The air to the carburetor is cleaned through inserts in the air cleaner. These inserts are replaceable and should be renewed after every 12,000 miles (20,000 km) or at least every two years. When driving on dusty roads, however, the inserts should be renewed at more frequent intervals. To change inserts, simply slacken the nut which holds the insert concerned. The inserts must be protected against moisture and must not be washed or oiled. The air cleaner also serves as an induction silencer.

NOTE

When washing the engine compartment, cover the air cleaner inserts so that they are not exposed to the wet.

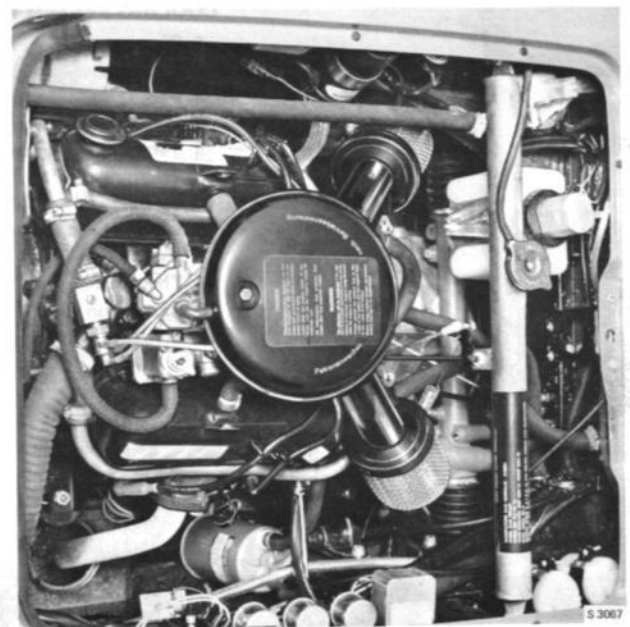

AIR CLEANER

Exhaust system

The Sonett III is equipped with two exhaust systems, one of which leads away the exhaust gases from cylinders 1 and 2 and the other of which leads away the exhaust gases from cylinders 3 and 4.

The two systems are in communication with each other via an exhaust manifold under the oil pan.

Cooling system

As the radiator is located rather low down in relation to the heat exchanger, the cooling system is provided with an expansion tank for filling with water. This tank consists of a tubular brace mounted between the wheel houses. Apart from having a slightly bigger radiator than in the standard version, the cooling system is identical with its counterpart in the Saab V4.

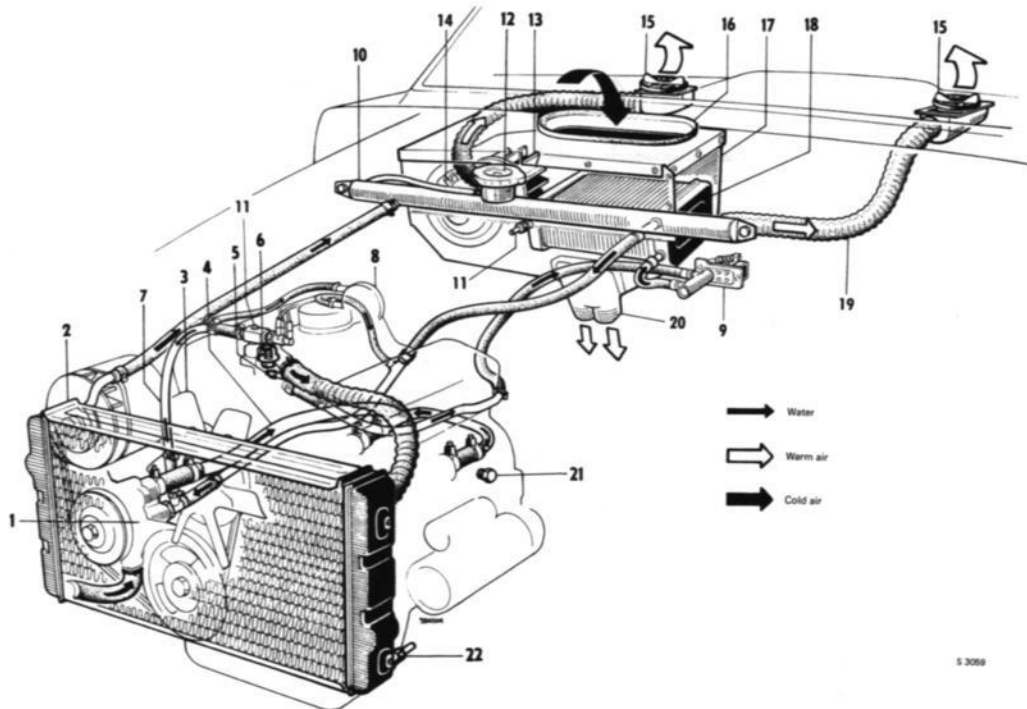

COOLING SYSTEM WITH FRESH AIR HEATER

- | | |
|----------------------------------|-------------------------------|
| 1. Water pump | 12. Filling cap |
| 2. Radiator | 13. Fan wheel |
| 3. Fan | 14. Heater fan motor |
| 4. Water distribution tube | 15. Defroster jet, adjustable |
| 5. Temperature transmitter | 16. Fresh-air intake |
| 6. Thermostat | 17. Collector box |
| 7. By-pass | 18. Heater core |
| 8. Water jacket, automatic choke | 19. Defroster hose |
| 9. Thermostat valve | 20. Air inlet |
| 10. Expansion tank | 21. Drain plugs (2) |
| 11. Bleeding nipples | 22. Drain valve |

Crankcase ventilation

The engine has totally enclosed crankcase ventilation. The principle is described in Section 200 in the Service Manual Saab V4.

REMOVAL AND INSTALLATION OF ENGINE BODY

Removal of engine

If work is to be done on the engine only, the entire power unit must be lifted out and the engine then separated from the transmission unit. Lifting out of the engine only is not to be recommended.

1. Disconnect the battery earth cable from the battery.
2. Jack up the car and place trestles in the front edges of the sills.
3. Remove the hood. See Group 8.
4. Drain off the coolant through the radiator draining tap. Remove the expansion tank cap and open the venting nipples on the heat exchanger and thermostat housing.
5. Disconnect the coolant hoses, detaching the upper hose from the engine and the lower one from the radiator. The hose to the expansion vessel must be detached from the latter.
6. Back off and remove the upper and lower radiator retaining screws and remove the radiator.
7. Remove the air cleaner. Place a plastic cover No. 783729 over the carburetor air inlet to prevent the entry of foreign matter into the engine.
8. Disconnect all hoses and cable connections from the engine. Disconnect the battery cable from the screws in the dividing surface between the engine and the transmission unit.
9. Disconnect the engine side braces at the two retaining screws in the cylinder head.
10. Remove the throttle control by unfastening the support from the induction pipe and pulling out the connection link to the throttle valve shaft.
11. Remove the two front engine cushions, working from above.
12. Back off and remove the exhaust pipe flange nuts at the cylinder heads. Separate the exhaust systems at the joints behind the exhaust manifold. Remove the spacers at the cylinder heads and lower the front exhaust system as far as possible.

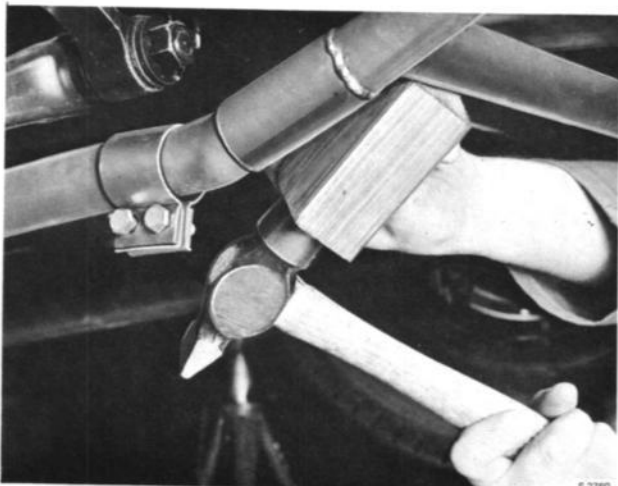

SEPARATING THE EXHAUST SYSTEMS

13. Disconnect the freewheel control and the speedometer cable from the gearbox. Back off and remove the clutch cylinder retaining screw and hang the cylinder up in a suitable position.
14. Remove the floor mat and the wallboard panels. Remove the gear lever knob and the rubber boot. Remove the transmission casing (4 screws).
15. Remove the right pedal plate to provide access to the rear engine bracket and the front gear shift rod joint. Remove the center screw from the engine bracket.
16. Remove the front taper pin of the gear shift rod joint by moving the nut over to the opposite end of the pin. The pin can then be removed by means of the nut. Open up the gear shift rod.



OPENING UP THE GEAR SHIFT ROD

17. Undo the large clamps round the rubber boots on the inner universal joints. To facilitate lifting and to avoid damaging the alternator and cooling fan, these items should be removed.
18. Attach the lifting device, tool No. 786202, see Fig., to a suitable hoist and lift the engine carefully about 2 in. (50 mm). Pull the transmission pin out of the rear engine bracket.

If the rear engine bracket is stuck, it can be knocked off with the aid of a suitable arbor, see Fig.

NOTE

The blow must be directed against the engine bracket and not against the transmission pin.

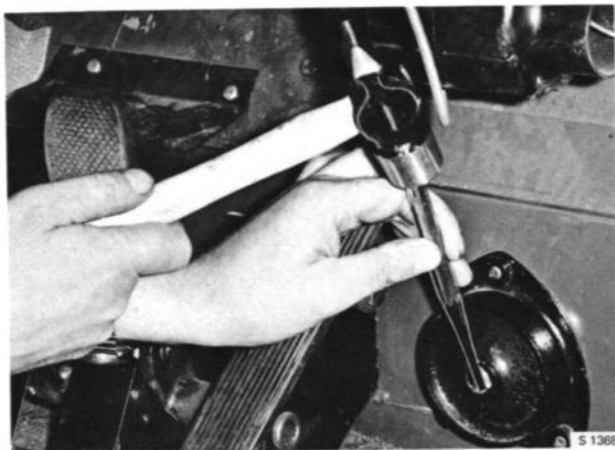

THE REAR ENGINE BRACKET CAN BE KNOCKED OFF WITH A HAMMER AND AN ARBOR

19. Open up the inner universal joints, first on the right side and then on the left. Do this with the T-shaped pieces of the drive shafts located vertically and with the engine unit pushed over as far as possible in the opposite direction. Fit protective covers 732373 in the rubber boots and 783846 on the inner drivers.
20. Lift the power unit out of the engine compartment. Make sure that the throttle control, expansion tank, etc., do not get damaged.
21. Clean the power unit and separate the engine from the gearbox if necessary.

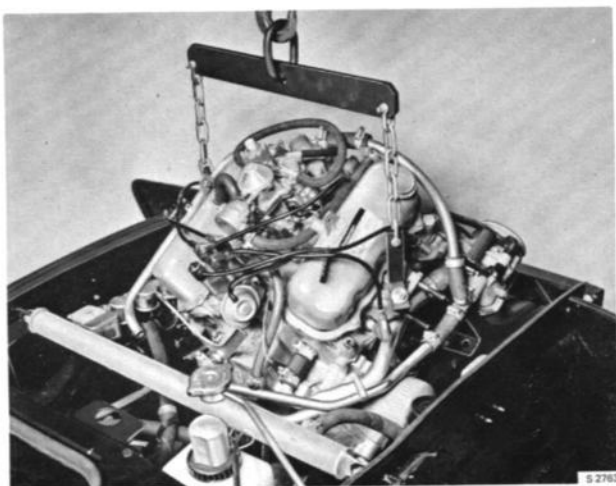

REMOVAL AND INSTALLATION OF POWER UNIT WITH LIFTING HOOK 786202

Installation

1. Check that the inner universal joints are filled with the appropriate grease. The joints must be completely filled with grease upon assembly.
2. Lift the power unit into the engine compartment, using lifting device No. 786202.
3. Lower the power unit so far that the engine brackets are about 2 in. (50 mm) from the engine cushions.
4. Place the T-pieces of the drive shafts in the inner universal joints. Do this with the T-pieces located vertically and with the power unit pushed over as far as possible in the opposite direction. Assemble first on the left side and then on the right.
5. Lower the power unit so far that the oil pan rests against the lower cross member. Transfer the left retaining iron of the lifting device to the upper screw for attachment of the gearbox on the left side. (This facilitates the next operation, as it gives a more suitable distribution of the weight.)
6. Lift the unit again and fit the transmission pin into the rear engine bracket and the gear rod into the hole in the dash panel.
This operation will be easier to carry out if an assistant guides the transmission pin in through the rear engine bracket with the aid of a suitable arbor. If necessary, also back off the four retaining screws for the steering gear so as to get more room.
7. Fit the limiting washer and center screw in the rear engine bracket. Refit the insulating washer.

NOTE

Check that the limiting washer on the rear of the engine bracket is in position and that it is turned in the right direction, see Fig. This washer serves to limit the forward movement of the power unit. If the washer is missing, there is a risk that the cooling fan will collide with the radiator if the brakes are applied powerfully.



FITTING THE LIMITING WASHER

8. Lower the engine and fit the front engine cushions. Fit the engine cushion nuts and spring washers.
9. Refit the two retaining screws for the side brace to the cylinder head.
10. Fit new clamps round the inner universal joints.
11. Refit the clutch cylinder. Adjust the clutch play.
12. Refit the speedometer cable and the freewheel control to the gearbox.
13. Refit the throttle control.
14. Fit the exhaust pipes together in the two joints. Do not push the upper pipes on so far that they rest against the floor in the bushings. Reconnect the exhaust pipes to the cylinder heads. Fit new gaskets.
15. Refit the alternator, cooling fan and fan belt if these items have been removed.
16. Reconnect all hose and cable connections to the engine.
17. Refit the radiator and reconnect all coolant hoses. Start with the lower hose.
18. Fill the radiator with cooling water and ventilate the system through the venting nipples on the thermostat housing and heat exchanger. Check the cooling system for leaks by carrying out a pressure test.
19. Check the oil level in the engine and top up if necessary.
20. Reconnect the earth cable to the battery.
21. Test-start the engine. Note the oil pressure and coolant temperature. Check the coolant level after running up the engine to the warm condition.
22. Refit the rubber boot on the gear shift rod. Check that the dash panel is positioned in the groove on the boot. Refit the gear shift rod joint.
23. Refit the pedal plate and the transmission casing. Put the wallboard panels and the floor mat in place.
24. Refit the hood. See Group 8.
25. Lower the car onto the wheels. Check the oil level in the gearbox and top up if necessary.
26. Take the car out for a test run.

FUEL TANK AND FUEL LINES

Removal of fuel tank

1. Take out the battery.
2. Jack up the rear end of the car and place trestles in the rear edges of the sills.
3. Empty the tank by detaching the lower hose from the fuel pump. Allow the gasoline to flow into a suitable container.

CAUTION
BEAR IN MIND THE RISK OF FIRE!

4. Remove the right seat. Remove the sheathing from the transverse partition behind the seats. Remove the fuel pipe from the tank, see Fig.



REMOVAL OF FUEL PIPE FROM TANK

5. Remove the sheathing from the back of the tank.
6. Disconnect the two tank retaining straps and remove the protective board.
7. Disconnect the fuel level transmitter earth wire (1) from the plate above the tank.
8. Unfasten the clamps for the filler and venting tubes. Pull the hoses off.
9. Pull the tank out slightly rearwards and disconnect the cables from the level transmitter (2). Disconnect the venting tube (3).
10. Lift the tank out through the rear lid.

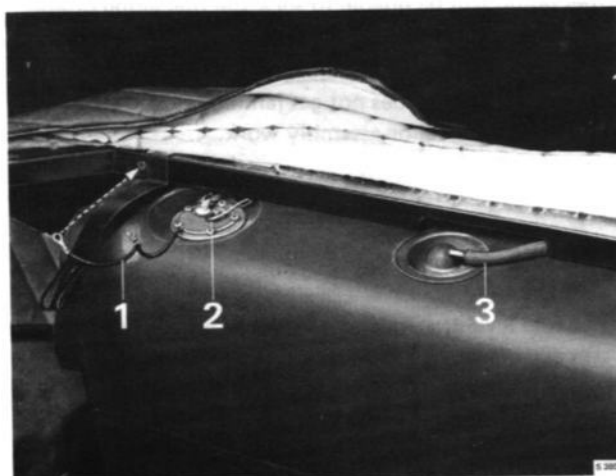

ELECTRICAL CONNECTIONS FOR FUEL LEVEL TRANSMITTER AND UPPER TANK VENTING TUBE

1. Fuel level transmitter earth wire
2. Fuel level transmitter
3. Venting tube

Installation of fuel tank

1. Lift the tank in and reconnect the venting hose at the top of the tank. Reconnect the cables to the fuel level transmitter as follows:
Gray cable to "G"
Brown cable to "W"
2. Reconnect the filler pipe and venting hoses.
3. Slide the tank into position and reconnect the fuel pipe.

NOTE

Check that the upper venting hose does not get squeezed so that it fails to function properly.

4. Reconnect the fuel level transmitter earth wire.
5. Refit the protective board and the tank retaining straps.
6. Refit the sheathing on the back of the tank.
7. Lower the car onto the wheels and fill up with gasoline. Check that the fuel line connection does not leak.
8. Refit the sheathing to the transverse position. Replace the right seat.
9. Refit the battery.

Checking fuel tank ventilation

It is vitally important for the ventilation hose not to be clogged, see Fig. page 200-3. If this hose is clogged, the fuel pump will be unable to suck the fuel along or else the tank can get sucked together and collapse. Check, therefore, that the hose is not clogged up with dirt, etc., and make sure that it does not get jammed or squeezed in course of removal or assembly work.

Fuel level transmitter

The fuel level transmitter consists of a float which, via an arm and a switch, actuates the fuel gage. When the fuel tank contains less than 1 3/4 US gals. (7 lit.) of gasoline, a red warning light in the fuel gage comes on. The fuel level transmitter is located on top of the fuel tank.

Removal

1. Remove the roll bar, see Group 8.
2. Remove the sheathing from the transverse partition, thus providing access to the fuel level transmitter through the hole above the transverse partition.

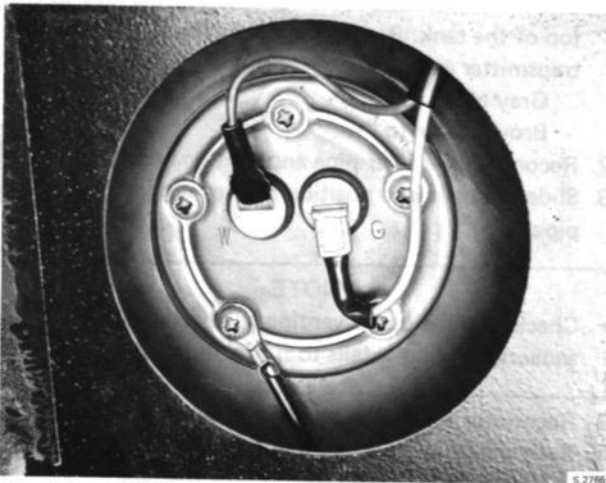

THE FUEL LEVEL TRANSMITTER IS ACCESSIBLE THROUGH A HOLE ABOVE THE TANK

Reassembly takes place in the reverse order.

Connect the electric cables as follows:

- Brown cable to "W"
- Gray cable to "G"
- Black cable to earth.

Fuel lines

The fuel lines consist of the following parts:

The front pipe, mounted on the floor of the engine compartment.

The rear pipe, which is mounted on the floor inside the passenger compartment.

Both pipes are interconnected by a jointing hose in front of the dash panel.

NOTE

The pipe must on no account be jointed inside the passenger compartment.

Removal of fuel pipes

A. Front part

1. Disconnect the battery earth cable from the battery. Jack up the front part of the car so that no fuel can flow through the pipe.
2. Remove the starter motor. Drain the fuel tank by disconnecting the lower hose of the fuel pump. Loosen the pipe from the connection at the fuel tank.
3. Undo the clamps on the right and left sides of the motor. There are two clamps on each side.
4. Undo the clamp on the joint and pull out the jointing hose. If necessary, remove the right front wheel and right tie rod to provide better accessibility.

B. Rear part

1. Take out the right seat, the floor mats and wallboard panels. Remove the transmission casing and the right pedal plate.
2. Drain the fuel tank by loosening the lower hose of the fuel pump. Loosen the pipe from the connection at the fuel tank.
3. Remove the plate washer mounted in front of the gear housing. Cut the pipe off at suitable points so that it can be removed.

Installation of fuel pipes

A. Front part

1. Cover the pipe openings with masking tape. Place the rubber wedge (right side) and the rubber-coated clamp (left side) on the pipe and put it in position.
2. Tear off the masking tape and reconnect to the fuel pump and jointing hose with clamps.
3. Refit the clamps, the starter motor and the battery cable.

B. Rear part

1. Refix the pipe nut and cover the openings with masking tape.
2. Insert the fuel pipe from the passenger compartment and as far as possible through the dash panel. Then backwards under the cross member and the partition, bending it gradually so that its shape conforms with that of the old pipe. Connect the pipe to the fuel tank.
3. Reconnect to the jointing hose with a clamp. Fit the rubber bushing in the dash panel.
4. Refit the rubber wedges and the plate washer.
5. Fill up the fuel tank. Check the tightness.
6. Refit the pedal plate, the transmission casing and the seat. Replace the wallboard panels and floor mats.

Cleaning the fuel system

If impurities are found in the fuel tank, both tank and line must be cleaned. This can be done by emptying the tank and flushing it out with pure gasoline or alcohol. Make sure that the tank is horizontally positioned, so that the impurities and foreign matter do not accumulate at one corner. If more thorough cleaning is required, it will be necessary to remove the tank. Detach the fuel pipe from the tank and pump and blow it clean with compressed air. Remove and clean the fuel pump filter. Change the filter in the line between the fuel pump and the carburetor. Lift off the carburetor cover, take out the float and the main jet, and blow clean with compressed air.

EXHAUST SYSTEMS

Mufflers and exhaust pipes

Front exhaust pipes with exhaust manifold

Removal

1. Jack up the front part of the car
2. Disconnect the battery cable.
3. Back off and remove the nuts at the engine connections. Remove the spacers.
4. Loosen the exhaust pipe clamps behind the equalizing pipe. Tap the pipe joints apart.
5. Remove the front pipe by lowering the right part and leading it out through the floor. Then turn the right part forward so that the left part can be lifted out.

Installation

Reassembly takes place in the reverse sequence. Always use new gaskets and check that good sealing is obtained at all connections. Make sure that the exhaust pipe is not subjected to stresses.

Seal between muffler and engine block

If leakage occurs between the front pipe and the engine, tighten the bolts. If this doesn't help, new gaskets must be fitted. Tighten the bolts carefully to avoid damaging the flanges.

Cracks

Cracked exhaust pipes or mufflers must be replaced or repaired by welding. Make sure that there are no residual stresses or permanent distortions in the pipes after welding.

Rear mufflers and exhaust pipes with front mufflers

Removal

1. Jack up the car and place trestles in the front and rear edges of the sills. Take off the rear wheels.
2. Loosen the clamps on the rear mufflers and front exhaust pipes.
3. Back off and remove the nuts for the rubber cushions of the rear mufflers. These nuts are accessible from the rear under the floor panel in the luggage compartment and under the side sheathing in the luggage compartment.
4. Detach the mufflers from their respective exhaust pipes.

5. Open up the exhaust pipe suspension rings and pull the pipe concerned out from the front exhaust pipe.

Installation

Reassembly takes place in the reverse sequence. Fit new rubber cushions and suspension rings. Make sure that the exhaust pipes are properly inserted in their connections, thus affording good sealing, and that no stresses are incurred in the rubber suspensions. If there are stresses or tensions in the exhaust pipes, vibrations may easily develop in the body of the car.

COOLING SYSTEM

Radiator with connections

Draining the cooling system

1. Remove the expansion tank cap.
2. The coolant is first drained off through the drain valve in the lower part of the radiator. If the cooling system is to be drained completely, also loosen the two hexagon plugs, located one on each side of the lower part of the engine block.
3. If the cooling system is to be thoroughly drained, the heat control on the fresh-air heater should be set at maximum heating.

Refilling the cooling system

Coolant is poured in through the opening on the expansion tank. The heat control should meanwhile be set at maximum heating and the bleeder nipples on the heat exchanger and on the thermostatic housing should be opened, thus enabling the system to be filled completely. When the cooling system has been completely filled, start the engine and run it at varying speeds for a minute or so, or until coolant emerges through the open bleeder nipples on the heat exchanger. When this occurs, close the nipples.

If necessary, pour additional coolant into the expansion tank and then replace the cap.

Only clean coolant may be used. Never pour in a large amount of cold coolant while the engine is hot, as this could cause the cylinder block to crack.

Check the level in the expansion tank after driving for a few days, as complete venting is achieved only after the system has been warmed up and cooled down a few times. Use a recommended coolant only.

Cleaning the cooling system

The cooling system is cleaned in accordance with the following procedures:

1. Drain off the water.
2. Flush the system with clean water.
3. Fill the system with clean water to which a suitable commercial solvent has been added. Follow the solvent manufacturer's instructions.
4. Shield the radiator and run the engine until warm.
5. Stop the engine and, after waiting a few minutes, drain off the water.

6. Flush the system again with clean water, treating the engine jacket and radiator separately. This time, flush against the normal direction of coolant flow, i.e. flush the engine jacket from the cylinder head and downwards, and the radiator through the lower connection pipe and upwards.
Before flushing the system this time, back off the upper water neck and remove the thermostat.
7. Flush the heater element, also against the normal direction of circulation.
8. Check the function of the tap in the line to the heater element.
9. Refit the thermostat, water neck and hoses. Test the system for leaks. When cleaning the cooling system, also check that the expansion tank overflow pipe is not choked up with foreign matter. If the cleaning method described does not suffice to clear all deposits from the radiator, take the radiator out of the car and send it to a specialist.

Pressure testing the cooling system for leaks

It is often difficult to discover leakage in the cooling system, as the pressure in the system reaches its full value only while the car is being driven. One good method is to put the system under pressure with the aid of a pressure tester, whereupon the radiator, hoses and seals can be checked. The maximum permissible pressure is 14 psi (1 bar, kp/cm^2).

The opening pressure of the pressure cap can also be checked with the pressure tester. See specifications in group 0, concerning opening pressures.

Testing the radiator for leaks

If the radiator is removed it can be tested for leaks by sealing the pipe connections, submerging it in water and testing with compressed air at max. 14 psi (1 bar, kp/cm^2). A leaky radiator can be repaired by soldering. Patent sealers which are added to the cooling water should be used only in emergencies. These compounds can choke jackets and pipes and impede circulation. The cells of the radiator core may at times be so clogged up with dust, smashed insects, etc., that the air flow is reduced. The core must then be washed and blown clear with compressed air.

Removal and installation of water distribution pipe or replacement of water hoses

Removal

1. Drain the coolant through the tap in the lower part of the radiator.
2. Slacken three hose clamps so that the hoses remain on the water inlet pipe.
3. Slacken the clamp which holds the water pipes together.
4. Remove the inlet pipe from the engine together with the hoses from the inlet pipe.

Installation

1. Moisten the hoses and ease them onto the water distribution pipe.
2. Hold the distribution pipe over the engine connection tail-pieces and ease on the hoses.
3. Tighten all hose clamps and pipe clamps.
4. Fill the system with coolant and bleed the system. Check that the system does not leak, by carrying out a pressure test.

Removal of radiator

1. Drain off the coolant.
2. Jack up the car and place trestles under the front edges of the sills.
3. Remove the horns.
4. Remove the screws holding together the upper and lower front stays. Bend the upper stay out of the way to provide access to the upper retaining screws of the radiator.
5. Disconnect the upper and lower coolant hoses from the radiator and the expansion tank hose from the tank.
6. Back off and remove the four radiator retaining screws and pull the radiator downwards. Pull it out right side first, and then turn the radiator rearwards and inwards so as to release the pipe on the left side. See Fig.

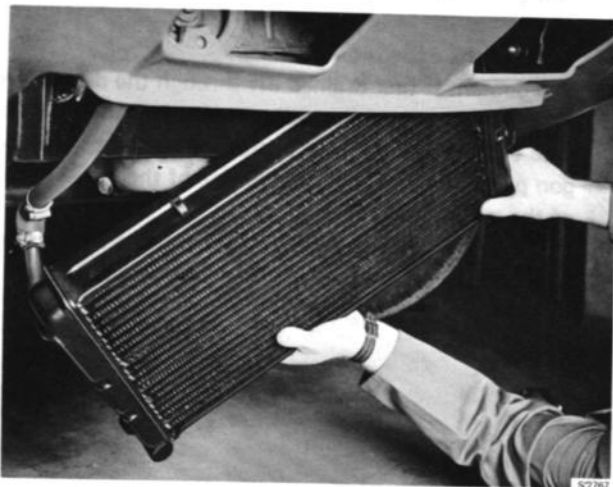

REMOVAL OF RADIATOR

Reassembly takes place in the reverse sequence. After having installed the radiator, fill up with coolant and bleed the system through the nipples on the thermostat housing and heat exchanger. Check that the system does not leak by carrying out a pressure test.

Expansion tank

Removal and installation

1. Undo the clamp on the water hose.
2. Remove the hose.
3. Back off and remove the tank retaining bolts.
4. Remove the tank.

Installation takes place in the reverse sequence.

CONTENTS

300	Description
311	Battery*
321	Generator
331	Starter*
	Ignition system
341	Ignition coil*
342	Distributor
344	Spark plugs*
346	Suppression of interference*
351	Lighting
	Electrical equipment other
361	Direction indicators
362	Horns
363	Windshield wipers and washer
364	Electrical controls and switches
371	Wiring and fuses

*) See Service Manual Saab V4.

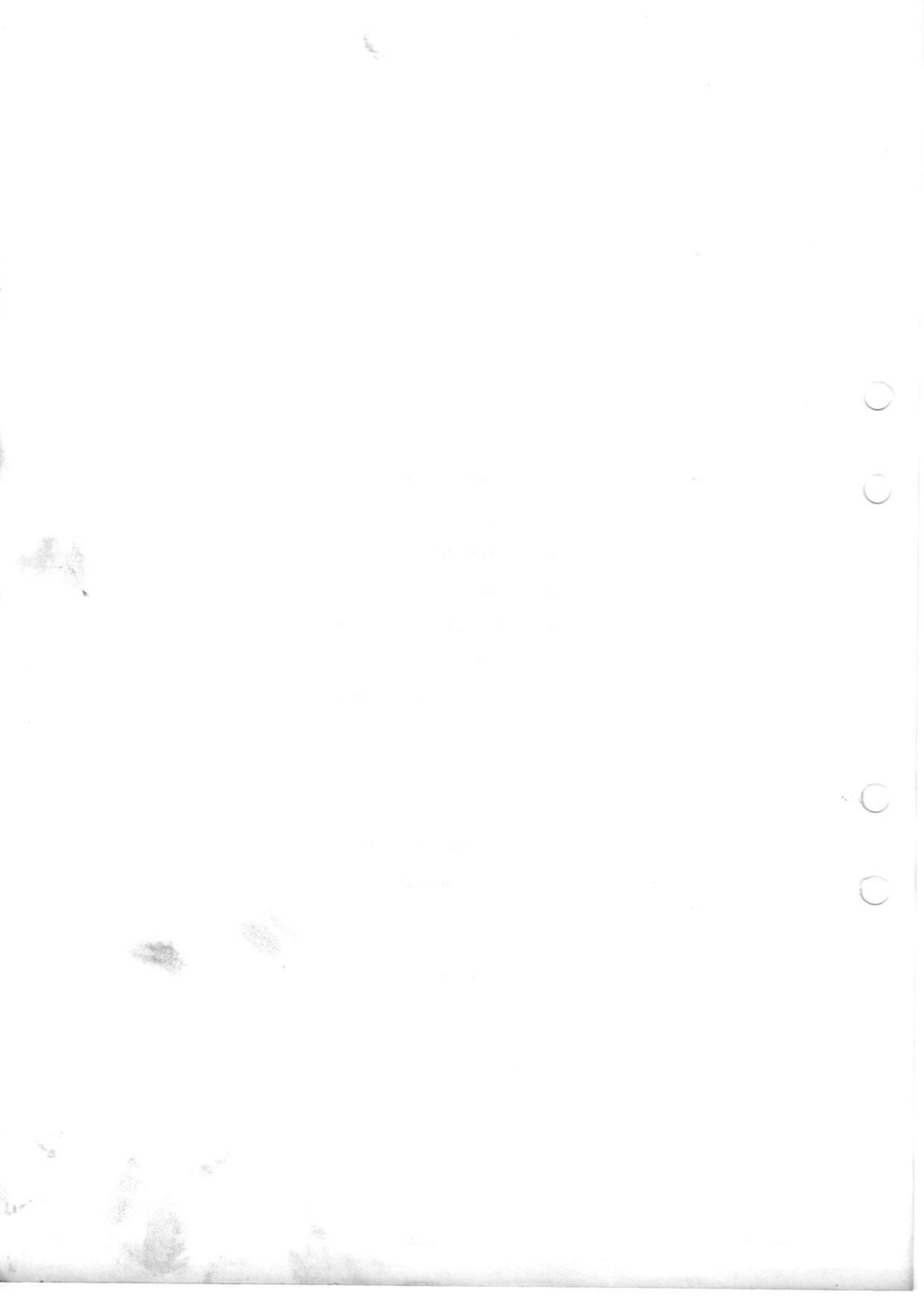

ELECTRICAL SYSTEM

Description

General

The electrical system in the Sonett III differs from that in the Saab V4 in the following respects: the headlights are mounted in retractable holders and light automatically when they are raised. Provisions are made for installation of extra lights in that switch, relay and cables are fitted. Installation of a radio receiver is also facilitated by factory-mounted wiring. The Sonett III is equipped with a cigarette lighter and an electric tachometer. An operating relay for the heater fan is provided. The brake light switch is hydraulic and the ignition lock is combined with a steering wheel lock.

Battery

The 12-volt, 6-cell lead battery has a capacity of 44 amp-hours (Ah). It is located under the trunk floor. The negative cable is earthed to the body.

Alternator

The alternator is of the same type as is installed in the Saab V4. An indicator light on the instrument panel shows whether the alternator is charging or not.

Starter

The starter has a rated output of 0,7 kW (1.0 h.p.) and is of the same type as is installed in the Saab V4.

Ignition system

The Sonett III has the same ignition system as the Saab V4. As from model 1971 the engine is provided with a PVS-valve (PVS = positive vacuum supply). See page 342-1.

Lighting

General

The road lights comprise the retractable headlights, direction indicators (flashers) and parking lights, side position lights, number-plate lights, rear lights with parking lights and back-up lights which light automatically when the gear lever is put to the reverse position.

The control switch for the back-up light is located on the gear lever housing.

The interior lighting comprises a map-reading lamp located under the instrument panel on the right-hand side. It is operated with a switch on the lamp and with the door switch at the left door.

The intensity of the instrument lighting can be regulated with a rheostat located on the left side of the instrument panel. A separate pull-out switch for the parking lights is provided in the middle of the instrument panel.

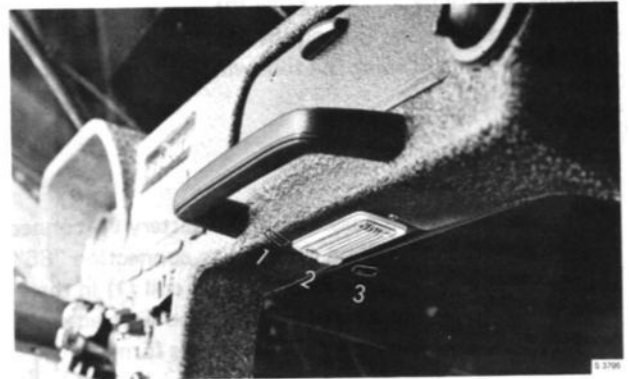

INTERIOR LIGHTING

1. Light is on
2. Light is off
3. Light switched on when opening the door

Headlights

The headlights are mounted in retractable holders which are carried in plastic bushings in the hood. The holders are raised and lowered with a control located on the left side of the instrument panel.

The lights are turned on automatically when the headlights are raised, which is done by pulling out the rod from the instrument panel. Switching between high beam and dipped beam is done with the lever for the dimmer switch (direction indicator switch). A warning light in the instrument panel glows blue when the headlights are on high beam.

The headlight inserts are vertically and horizontally adjustable.

Switching on and dimming

When the headlights are raised, i.e. when the pullrod for headlight operation is moved rearwards, the lever of the microswitch is released and, provided that the ignition is engaged, two current circuits are actuated. In one of these circuits, current goes from the battery via the ignition lock to the magnetic coil in relay (4) and then via the microswitch to earth. In the other circuit, the current goes the same way, except that in this case it passes through the magnetic coil in relay (5).

The contacts in relays (4) and (5) are closed by the magnetic force, thus forming the following current circuits:

Circuit A

In this circuit, current passes from the battery via connections "30/51" and "87" on relay (5) to connection "86" on the light relay and continues through coil (1) in the relay to earth. The contact at coil (1) is now attracted to its lower position and a new circuit is thus formed.

Circuit B

Current passes from the battery via connection "30" to the contact (3) and continues either via "F" to high beam or via "56a" to dipped beam. Contact (3) is actuated mechanically by the contact at coil (2) and switches position every time the coil is excited, which occurs according to the next circuit.

Circuit D – Dimming circuit

The dimmer lever is moved rearwards, thus enabling current to pass from the battery to connection "30" and from thence through the coil (2) and connection "S" via the dimmer switch to earth. The contact at coil (2) is attracted and contact (3) switches position.

Circuit D

Contact (3) is in its lefthand position, i.e. high beam is switched on.

1. Current goes to the warning lamp for high beam.
2. If the switch for the extra lights is turned on, relay (6) is activated.
3. If extra lights are installed, current is passed to these from the battery via connections "30/51" and "87" on relay (6).

Circuit E

When the microswitch is engaged, a current circuit is also formed from the battery and via connections "30/51" and "87" on relay (4) to the parking light. This is a safety device which automatically turns on the parking and side position lights as well as the number lights if the switch for these is not turned on when the headlights are raised.

The reason why the light relay has been equipped with a connection relay (5) is so that the current intensity through the microswitch will be as low as possible. The light relay is so designed that it can also be used for so-called high-beam signalling, but on the Sonett III this possibility can only be utilized if extra lights are installed, since the standard headlights are lowered when switched off. When a high-beam signal is given, which is done with the dimmer lever and with the switch for the extra lights turned on, current passes through coil (2) in the light relay, whereas coil (1) remains inactivated. The contact at coil (1) is thus in its upper position and that at coil (2) in its lower position.

The current will then pass through the following circuit: Battery – Connection "30" – Contact at (1) – Contact at (2) – Connection "F" – Switch for extra lights – coil in relay (6) – earth. The contact in the relay is attracted and current is passed to the extra lights.

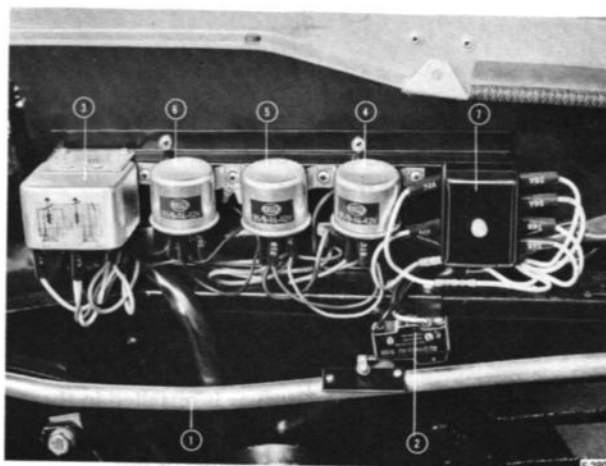

LOCATION OF RELAYS, MICROSWITCHES AND FUSE BOX

1. Pullrod
2. Microswitch
3. Light relay
4. Relay for automatic switching on of parking lights
5. Relay for engagement of light relay
6. Relay for extra lights
7. Fuse box for headlights

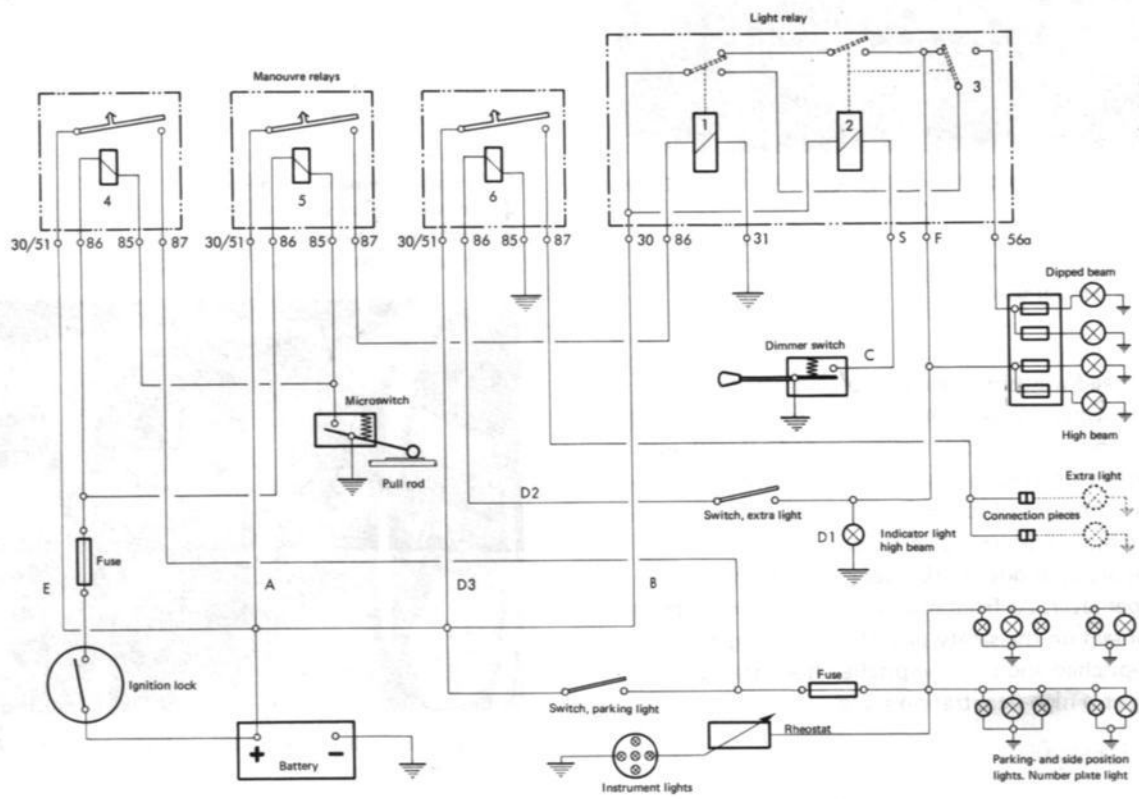

WIRING DIAGRAM FOR LIGHTING

S 3612

Miscellaneous electrical equipment

An automatic reset switch located under the steering wheel controls the current to the direction indicators. It also serves as a dimmer switch. A green warning lamp on the instrument panel indicates when the direction indicator (flasher) is operating.

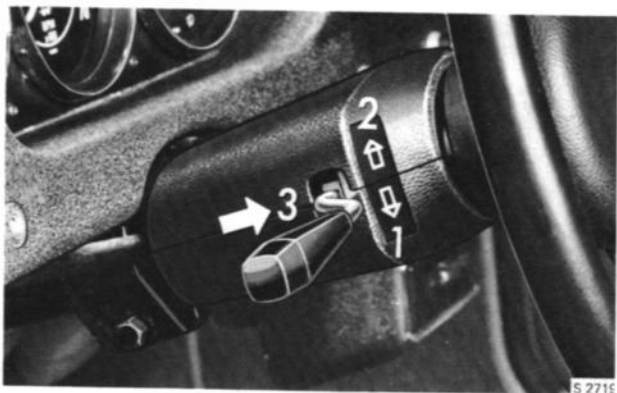

COMBINED DIRECTION INDICATOR LEVER AND HEADLIGHT DIMMER SWITCH

1. Left direction indicator
2. Right direction indicator
3. Headlight dimmer switch

The two-speed windshield wiper motor drives the two windshield wipers via twin linkages (as from model 1971 via a reversible cable) and is turned on and off with a switch on the steering column stand. This switch is combined with the control for the windshield washer, the pump of which is driven by an electric motor.

The horns are on model 1970 operated with the windshield wiper lever. As from model 1971 they are operated with a contact on the safety pad of the steering wheel. One high-pitched and one low-pitched horn are harmonized to give a high-penetration signal.

The Sonett III is equipped with a hazard warning signal switch, located in the middle of the instrument panel. When the button is pulled out, all direction indicator lights and the corresponding warning lamps flash simultaneously.

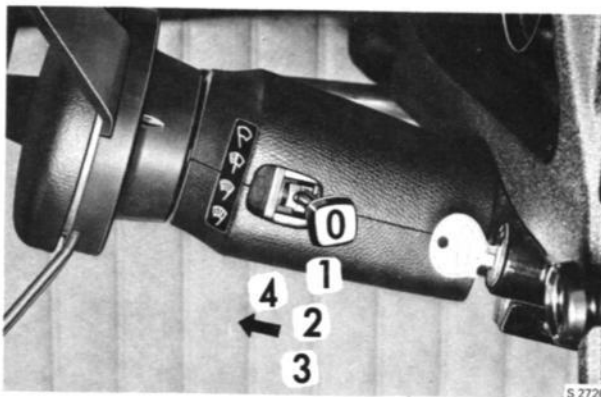

WINDSHIELD WIPER/WASHER CONTROL LEVER AND SIGNAL HORN LEVER, MODEL 1970

0. Neutral position
1. Windshield wipers, half speed
2. Windshield wipers, full speed
3. Windshield wipers, full speed + washer
4. Signal horn (works in positions 0-3)



WINDSHIELD WIPER/WASHER CONTROL LEVER, AS FROM MODEL 1971

0. Neutral position
1. Windshield wipers, half speed
2. Windshield wipers, full speed
3. Windshield wipers, full speed + washer
4. Washer (works in position 0, 1, 2)

The Sonett III features the same type of brake warning system as is used in the Saab V4. With regard to the location and setting of the warning switch, see section 364 "Electrical controls and switches".

The stop-light switch is hydraulic and is mounted on the secondary circuit of the master cylinder.

To ensure that the car will not be left unlocked, a buzzer is activated if the door is opened with the key left in the ignition lock.

Wiring and fuses

The various wires from the battery or generator to the different electric-power consumers are gathered into a harness network that is arranged in groups. The individual wires are color-marked for easy identification throughout the network.

The wiring connections consist of solderless AMP connectors. Fuses are provided to protect wiring etc. from abnormally high current intensities (due to short circuits for instance) and to reduce fire hazards. The fuses are located in two fuse boxes, one under the engine hood lid on the left-hand wheel housing and one under the instrument panel at the left-hand door.



FUSE BOX UNDER INSTRUMENT PANEL

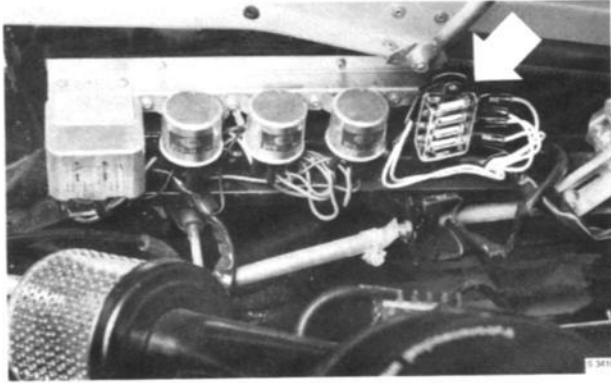

FUSE BOX IN ENGINE COMPARTMENT

ALTERNATOR

General

While the car is running, the alternator supplies the current needed by the various items of electrical equipment and at the same time charges the battery.

To remove the heat generated in the alternator, its drive pulley is provided with fan vanes that draw air through the alternator as long as it is running.

The alternator is driven by a belt from a pulley on the crankshaft and is located on the right-hand side of the engine.

IMPORTANT

The generator must not be run with the battery disconnected. The battery cable connections must not be reversed, as this will result in serious damage to the alternator.

The alternator needs very little maintenance, as no carbon brushes or commutators are needed to conduct the power produced. It has two slip rings and two brushes to supply exciter current to the rotor field windings, but these slip rings and brushes are subjected to such small loads that they do not normally need attention.

Consequently, no maintenance schedule has been set up for this alternator. Any necessary repairs should be done by a specialist electrical workshop; it is essential that disassembly and testing are properly carried out, as even small errors may result in extensive damage.

NOTE

The charge indicator light is used to excite the alternator. It should have a power of 1.2–2 W.

CAUTION

Before any electric welding is done on a car equipped with an AC generator (alternator), the battery ground cable and all wiring to the alternator must be disconnected, as the rectifier diodes may otherwise be damaged.

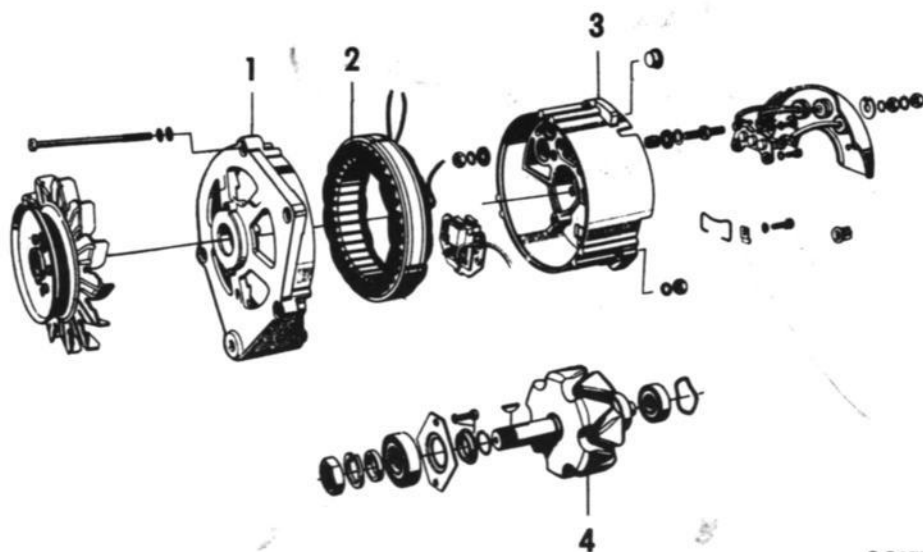

S 2157

ALTERNATOR

1. Drive end frame
2. Stator
3. Slip ring end bracket
4. Rotor

Designation

The Bosch type designation of the alternator is

K1 ← → 14V 35 A 20

The meaning of this designation is explained below.

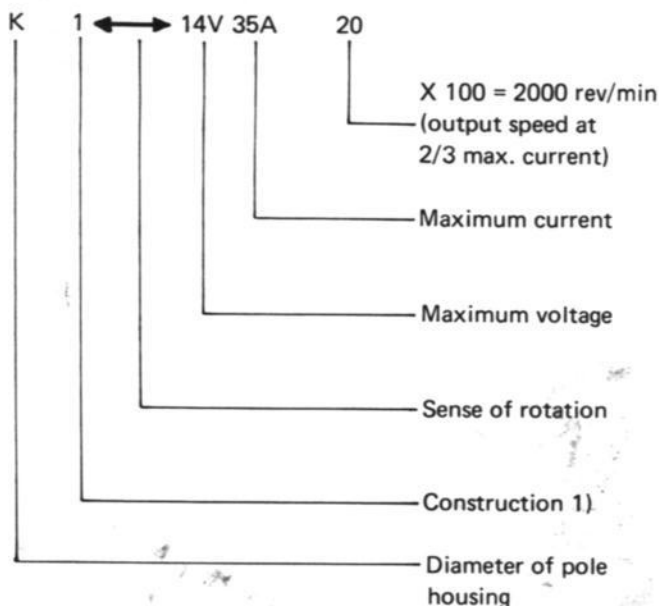

- 1) Construction: 1 = One coil and several poles
2 = One coil per pole
3 = Without slip rings

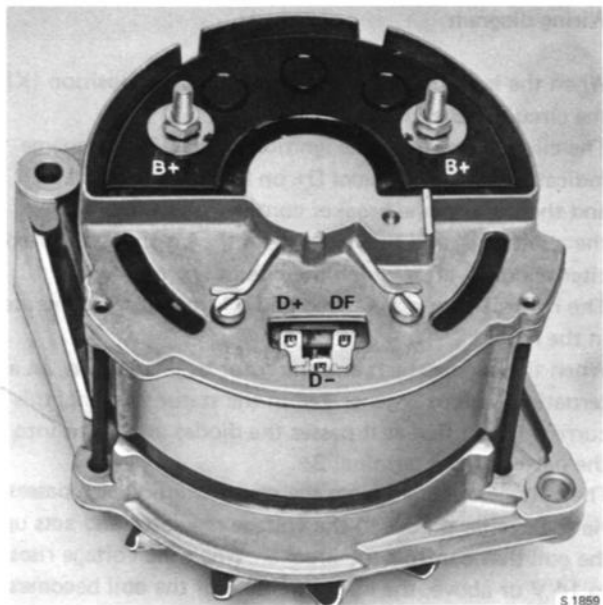

TERMINAL END OF THE ALTERNATOR

Terminal clamps

- D+ Exciter diode output, terminal for regulator D+
DF Terminal to exciter winding and for regulator DF
B+ Battery connection

The indicator light is wired to D+ on the voltage regulator. Connection to D- on the regulator is by a wire in the tripole joint housing.

Description – internal wiring

The 12 volt alternator is internally ventilated. It has a 12-pole rotor and six silicon diode rectifiers. An exciter diode is connected to each of the three stator windings, with a common grouping point at terminal D+. The six rectifier diodes are arranged and wired in an AC bridge, i.e. three diodes are wired for normal polarity (anode to the terminal) and the other three for reverse polarity (anode to the casing). According to polarity, the diode holder is insulated from the body or directly grounded by a body contact. The holder for the exciter diodes is insulated and located below the holder for the three diodes of normal polarity.

The stator winding is star coupled (see wiring diagram). The annular exciter winding is mounted on the rotor, which has pole claws, one half of the claw acting as a north pole and the other as a south pole. The ends of the exciter winding are connected to slip rings which transmit the exciter current.

Wiring diagram

When the ignition key is turned to the drive position (K), the circuit is energized.

The circuit runs from the ignition switch via the charge indicator light to terminal D+ on the voltage regulator and thence over the breaker contact to terminal DF on the alternator, and finally through the brushes to the exciter winding, after which the circuit is grounded.

The rotor is thus magnetized and a force field is generated in the rotor.

When the engine starts and the rotor begins to spin, an alternating current is generated in the stator winding; this current is rectified as it passes the diodes and is fed into the battery from terminal B+.

The voltage obtained from the stator winding also passes via the exciter diodes to the voltage regulator and acts upon the coil that controls the breaker. When the voltage rises to 14 V or above, the magnetic field of the coil becomes so powerful as to overcome the spring resistance of the regulating contact and break the circuit.

The current to the exciter winding is then forced to go through the resistance and is thus reduced, whereupon the magnetic field strength diminishes, and with it the strength of the alternating current generated in the stator winding. The voltage regulator thus governs the voltage to a maximum of about 14 V.

The charge indicator light is also influenced by the voltage output from the stator winding via terminal D+ on the regulator, in such a way that the voltage is equal on both sides of the light and the light is therefore extinguished. This is an indication that the alternator is charging.

No current-limiting relay is needed, since the alternator itself governs the current intensity. At high alternator speeds, when the frequency of the alternating current is also high, and when the intensity of the output current reaches a given value, the resulting resistance (impedance) assumes such a magnitude that no further increase of current is possible.

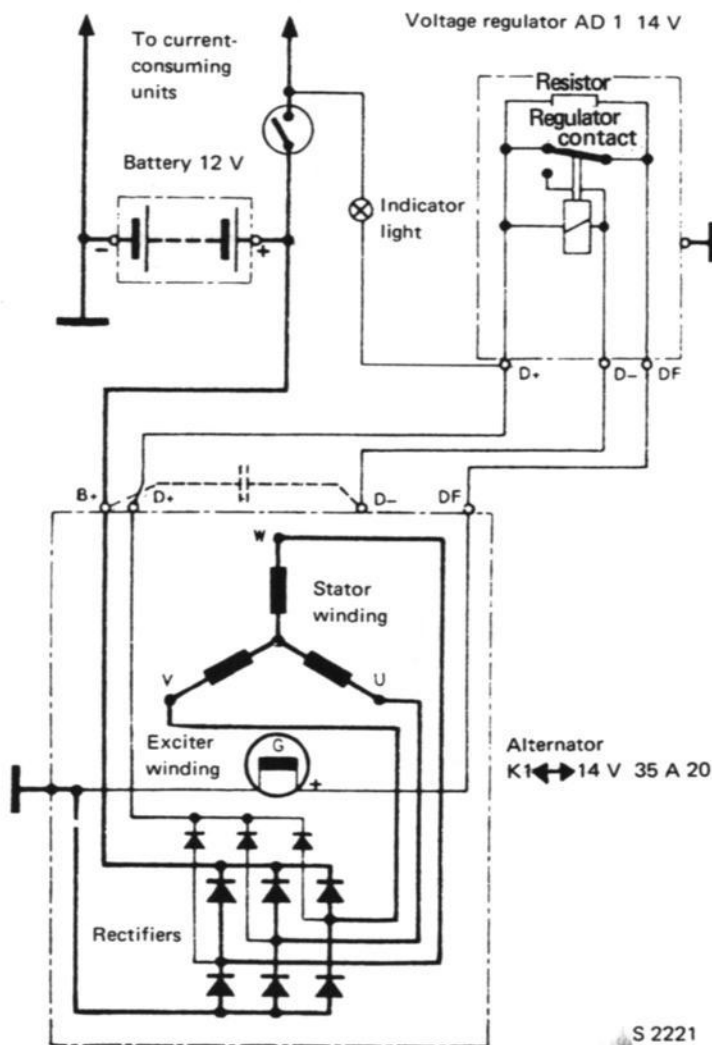

S 2221

WIRING DIAGRAM FOR A. C. ALTERNATOR

Quick checking of alternator and charging regulator

If the charge indicator light does not go out, the first thing to do is to check that the alternator belt is not slipping and/or that the cable connections have not loosened. If the lamp still glows after checking in this way, the cause can be determined in the following manner: Remove the connector from the charging regulator. Connect a cable between the red cable's terminal D + and the yellow cable's terminal DF.



S 2973

TERMINALS DF AND D+ CONNECTED

Start the engine and let it run at max. 2.000 rev/min while watching the charge indicator light.

WARNING

Do not run the engine at a higher speed than 2.000 rev/min, as there is a risk of damage to the power consumer being caused by overvoltage.

If the indicator light goes out immediately, the charging regulator is defective and must be renewed. If the indicator light flashes or lights continuously, the alternator must be overhauled.

Removal and installation of alternator

1. Disconnect the battery negative cable. Note that the engine must be stopped before the cable is detached.
2. Remove the engine lid and the right valve casing.
3. Remove the windshield washer from its holder and detach the throttle control spring from the control arm shaft. Back off and remove the two retaining screws holding the expansion tank. Lift the tank to one side so that the hose is not in the way.
4. Disconnect the alternator cables. Back off and remove the retaining and adjusting screws and remove the alternator.

Removal and installation will be facilitated by slackening the screw for the retaining bracket by the water pump. The bracket can then be opened up.

Reinstall in the reverse sequence and then adjust the alternator belt (fan belt) so that it can be pressed down approx. 0.3 in. (7 mm) at a load of 15 N (3.5 lb., 1.5 kp). Refit the valve casing, using a new gasket.

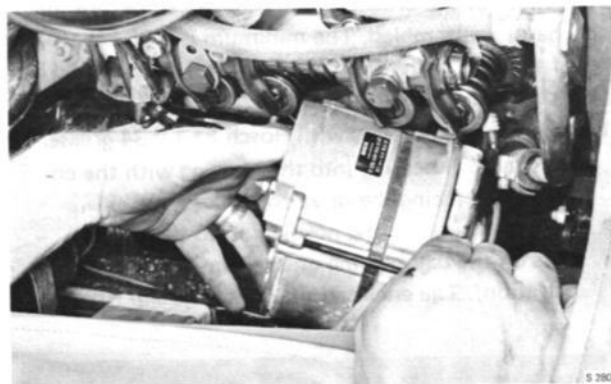

S 2908

REMOVAL OF ALTERNATOR

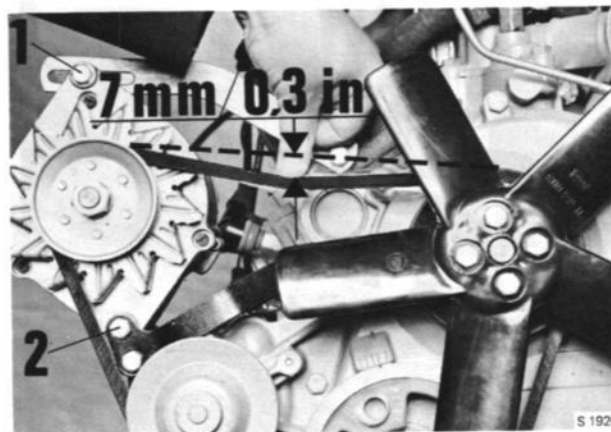

S 1926

ADJUSTMENT OF FAN BELT TENSION

1. Adjusting screw
2. Retaining screw

Disassembling the alternator to exchange the bearing

1. Hold the belt pulley securely in a suitable tool and unscrew the nut with a 7/8" (22 mm) wrench. Remove the pulley and fan disc.
2. Mark the position of the tension lug on the drive bearing housing. Undo the bearing housing retaining screws and withdraw the rotor together with the bearing housing from the stator.
3. Place the drive bearing housing on a suitable backing surface and carefully press out the rotor. The bearing can then be removed. Take care that the rotor does not fall to the floor and suffer damage when it comes free of the bearing housing.
4. Use a suitable puller to remove the ball bearing from the slip ring side.

Assembling the alternator

The length of the brushes must be checked before the alternator is assembled. The minimum is 0.354 in. (9 mm), but if they are under 0.551 in. (14 mm) they should be replaced. See section on "Changing brushes".

1. Pack the ball bearings with Bosch Ft 1 v 34 grease. Press the ball bearing into the housing with the enclosed side facing the drive end.
2. Press the drive bearing housing on to the rotor.
3. Press on the ball bearing on the slip ring side (see illustration). The enclosed side faces the slip rings.



S 998

PRESSING THE SLIP RING BALL BEARING INTO POSITION

4. Put the spring washer into the bearing seat. Push up the brushes and secure them with the brush springs (this is easier if the brush unit assembly is removed).

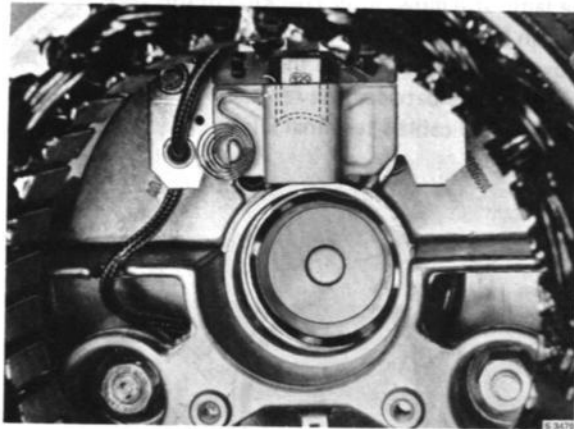

BRUSHES PUSHED UP AND SECURED

5. Insert the rotor and screw the assembly together. Make sure that the drive bearing housing is correctly positioned relative to the slip ring bearing housing. Press the brushes down from the outside with a screwdriver or similar.

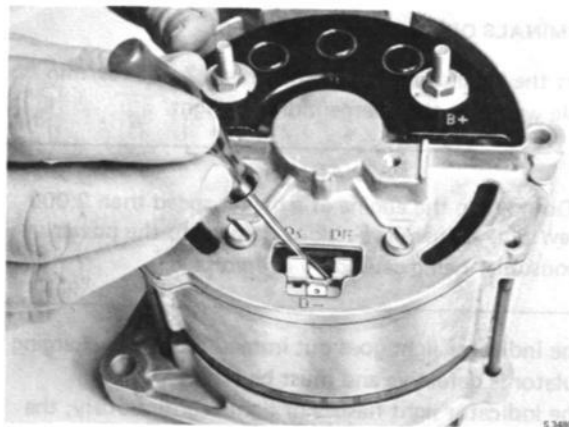

PRESSING DOWN THE BRUSHES

6. Fit the fan and belt pulley. The large spacer is to be placed between the fan and the belt pulley. The small spacer is to be placed between the belt pulley and the spring washer. Tighten the nut to a torque of 23-29 ft.lb. (34-39 Nm, 3.5-4 kpm).

Changing brushes

Min. length of the brushes is 0.354 in. (9 mm). If the alternator is renovated the brushes shall be replaced if they are under 0.551 in. (14 mm).

1. Mark the position of the tension lug on the drive bearing housing. Undo the bearing housing retaining screws and remove the rotor with the bearing housing from the stator.
2. Undo both nuts holding the rectifier bridge in place.
3. Undo the terminal screw of the connecting wire to the brush unit assembly (see illustration).
(Later alternator models are fitted with AMP-connections.)



DISCONNECTING THE BRUSH UNIT ASSEMBLY WIRE

4. Undo the brush unit assembly retaining screws and remove the assembly (see illustration).

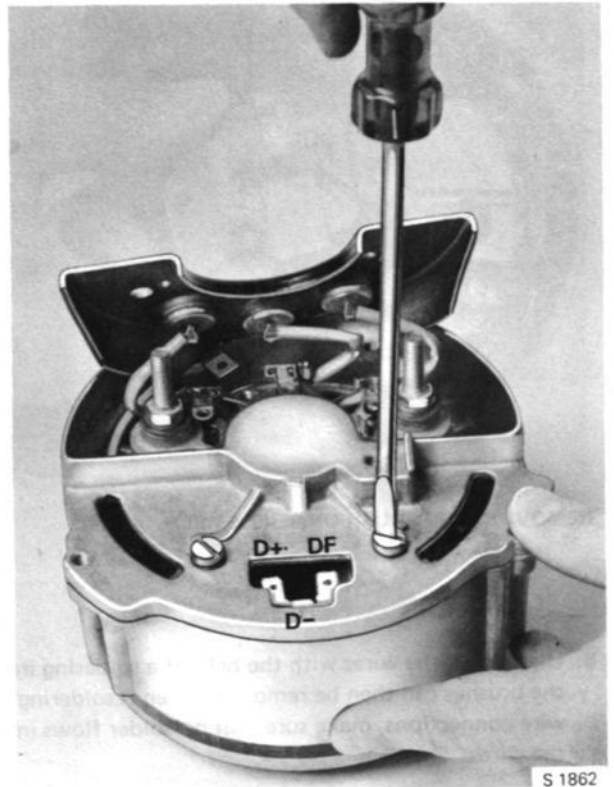

UNSCREWING THE BRUSH UNIT ASSEMBLY

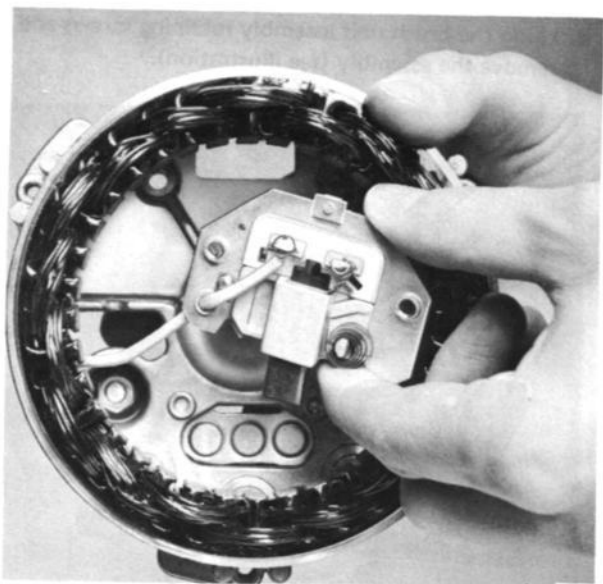

S 1863

REMOVING THE BRUSH UNIT ASSEMBLY

5. Disconnect the wires with the help of a soldering iron; the brushes can then be removed. When resoldering the wire connections, make sure that no solder flows into the wires.

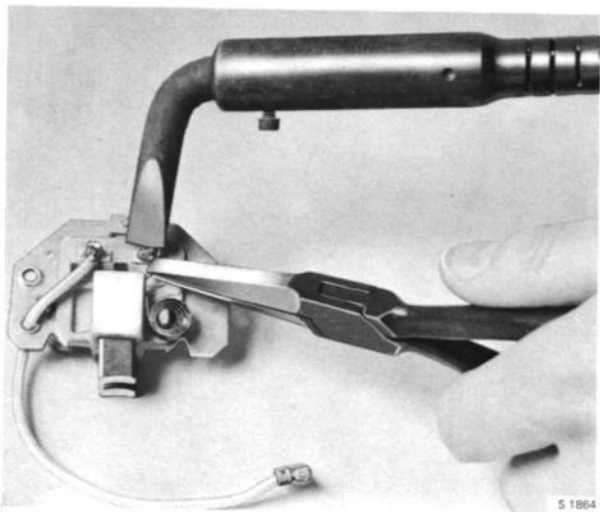

S 1864

UNSOLDERING THE BRUSH UNIT TERMINALS

6. Push up the brushes and secure them with the brush springs. Fit the brush unit assembly and make sure that the spring washer is in its correct place in the bearing seat.
7. Insert the rotor and screw the assembly together. Make sure that the drive bearing housing is correctly positioned relative to the slip ring bearing housing. Press the brushes down from the outside with a screwdriver or similar.

Testing

Note the following before testing the alternator or its component parts:

Only direct current with a maximum voltage of 24 V may be used to test rectifiers.

A glow lamp (110 or 200 V) must not be used for insulation and short circuit tests, as it may cause damage to the rectifiers.

The rectifier diodes must be unsoldered before the stator winding insulation is tested at 80 V/40 W.

The battery cables must not be disconnected while the engine is running for the purpose of measuring the charging current.

If it is necessary to solder or unsolder diode connections, the diode connecting wire must be held in a pair of flat pliers to conduct away excess heat, on account of the heat sensitivity of the semiconductors. (Solder and unsolder the connections quickly with a hot soldering iron.) Avoid mechanical strain at the point where the connecting wires issue from the heat sink assembly; the wire must not be bent or subjected to load at the point of attachment.

During repairs to the alternator, whether in the car or on a test bench, the battery must be disconnected. Only instruments having not more than 8 V voltage may be used for measuring resistances on the assembled alternator.

Testing the alternator on a test bench

When on the test bench, the alternator must be driven by its belt pulley only.

Connecting wires must be fitted with cable shoes or pin connectors. Improvised connectors must not be used on the battery either.

During testing a 12 volt battery must be coupled in parallel with the alternator. The battery serves as a buffer to damp out the peak voltages that occur when the load is switched on and off. If these peaks exceed the permitted maximum voltage, the rectifier effect of the diodes will be lost. The voltage limit for silicon diodes is about 50 V.

Magnetization

Unlike a DC generator, the alternator does not demagnetize spontaneously after a long period of disuse. A 12 V indicator lamp with a power of at least 1.2–2 W must therefore be connected between terminals D+ and B+ (see wiring diagram). Bias current is then supplied to the exciter winding through the indicator light, alternator terminal D+, regulator terminal D+, the closed regulator contacts and terminal DF. It is important in this connection that the lamp wattage is at least as high as that stated above. Self-excitation begins as soon as the alternator voltage opens the exciter diodes, which occurs at 1–2 V. The voltage then rises rapidly and the potential difference across the indicator lamp gradually diminishes. The lamp remains lit until battery voltage has been attained.

Mounting the alternator

The alternator can be tested in most types of generator test bench. In some cases it may be necessary to provide suitable extra mounting and drive arrangements.

CAUTION

When mounted for testing the alternator must be secured by screws in the normal manner and not clamped in place or secured by other means.

Testing with the voltage regulator

Mount the alternator in the test bench and connect it to the voltage regulator. **Do not misconnect the terminals!** Connect the excitation ammeter to terminal DF on the alternator. Connect the battery and indicator lamp. Connect the voltmeter to terminal B+. For bias, increase the speed from zero until an alternator voltage of about 14 V is obtained, then reduce speed again.

Testing at 2/3 maximum current

Connect the battery and load the alternator. Adjust the speed to exactly 2000 rev/min. The alternator must then deliver two-thirds of the maximum current, i.e. 23 A.

Checking speed for maximum output

Connect the battery. Load the alternator and run it warm. Increase speed. The maximum output of 35 A at 14 V should be obtained within the speed range 2700–3700 rev/min.

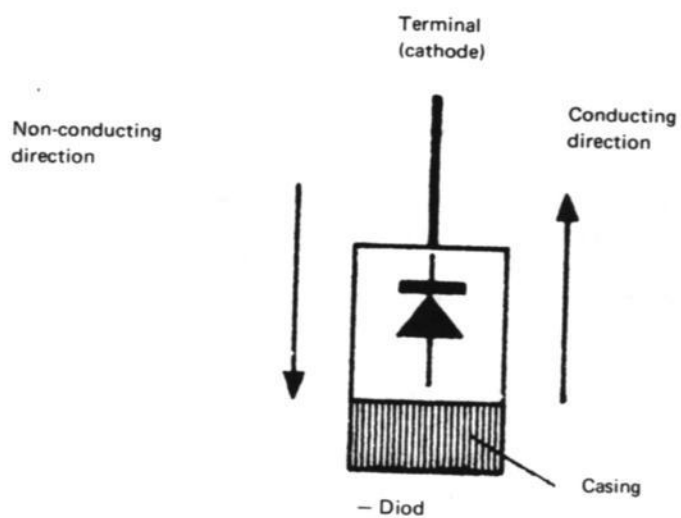
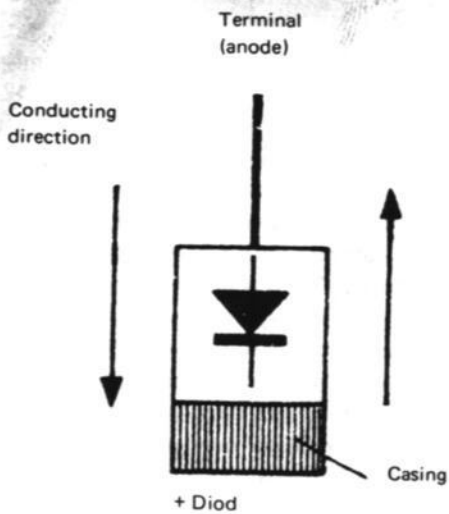

S 2227

Testing alternator components

Testing the rectifiers

Use only a testing lamp of not more than 24 V or an ohmmeter. To test the conducting and non-conducting directions of the silicon rectifiers, the phase terminals must first be disconnected, as it is otherwise impossible to tell which diode is faulty. The positive diodes between terminal B+ and phase conduct from the terminal to the casing but not from the casing to the terminal. The negative diodes connected between phase and B- (inverse polarity) conduct from the casing to the terminal but not from the terminal to the casing (see illustration). To test this, connect the testing lamp in series with the diode under test. The lamp should light up when B+ is connected to the anode of a diode with normal polarity. The lamp should not light up when B+ is applied to the casing. If the diode has inverse polarity, the lamp will light up when B+ is connected to the terminal (cathode) but not when the direction of current flow is reversed. A faulty diode that fails to pass current in the conducting direction has been overheated by excessive current intensity. A diode that passes current in both directions has probably been subjected to excessive voltage.

Testing rectifiers with an ohmmeter

The rectifiers can also be tested with an ohmmeter. In a properly working diode, resistance is low in the conducting direction (e.g. a few ohms) but much greater in the non-conducting direction (e.g. several kilohms).

Testing the stator windings

Short to ground (rectifiers unsoldered)

The stator windings can be tested for shorting in the normal manner with a testing lamp of not more than 40 V.

The test can be performed with the rectifiers connected, provided that the non-conducting direction of the diodes is allowed for. The positive contact of the testing lamp must be connected to the stator winding and the negative contact to the diode casing; if this method is adopted, the test voltage must not exceed 24 V.

Short in the windings (rectifiers unsoldered)

The test for shorting in the stator windings can be made with the probe of a winding tester. This test can only be made when the alternator is disassembled. A further possibility is to measure the joint resistance in two phases. With three measurements, any deviation in the resistance of the stator winding can be detected. If the phases are marked U, V and W, measure U-V, U-W and V-W. In each case the reading should be: 0.26 ohms + 10% (at 68°F/20°C).

Testing the exciter winding (rotor)

Short in the winding

Use an ohmmeter to measure the resistance of the winding from slip ring to slip ring. The resistance should be 4.0 + 0.40 ohms.

Short to ground

Test the insulation of the exciter winding and slip rings by checking for shorts to ground (test voltage 40 V).

DISTRIBUTOR

The distributor is identical with the Saab V4 distributor. As from model 1971 the vacuum advance operates via a PVS-valve (PVS = positive vacuum supply). The valve is fitted on the thermostat housing and feels the temperature of the coolant. When the temperature of the coolant is raised above +225°F (107°C) the valve readjusts the vacuum advance so that the idling will be faster and the engine cooling will be improved. Concerning removal, disassembly etc. of distributor, see Service Manual Saab V4.

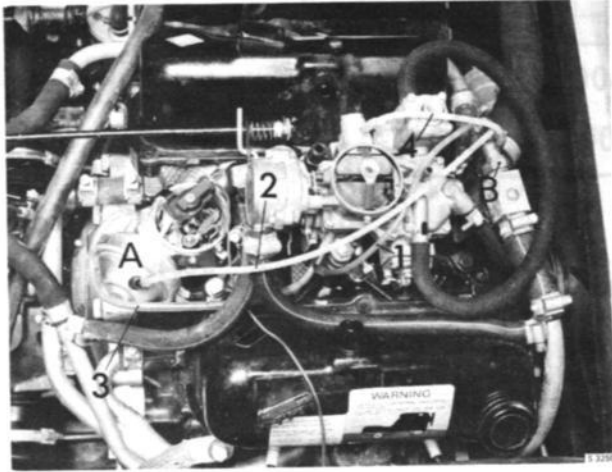

ARRANGEMENT OF VACUUM HOSES FOR DISTRIBUTOR AND PVS VALVE, AS FROM MODEL 1971

- A. Vacuum regulator
- B. PVS valve
- 1. Hose from carburetor to position 1 on PVS valve
- 2. Hose from vacuum regulator to position D on PVS valve
- 3. Hose from vacuum regulator (retard side) to intermediate flange
- 4. Hose from deceleration valve to position 2 on PVS valve

Model 1970

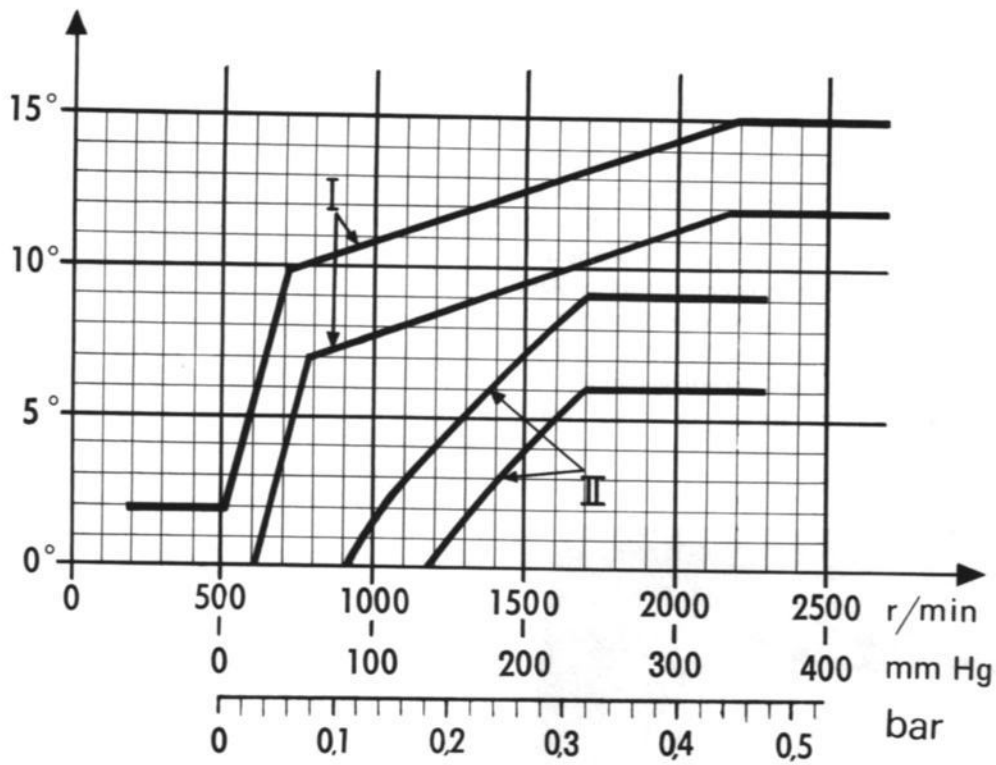

S 3549

CENTRIFUGAL AND VACUUM ADVANCE DISTRIBUTOR
0 231 146 084 AND 0 231 146 092

Dwell angle $50 \pm 2^\circ$

Contact pressure 3.9–5.2 N (14–19 oz, 400–530 p)

I = Centrifugal advance r/min = Distributor rev./min
II = Vacuum advance mm/Hg = Underpressure

As from model 1971

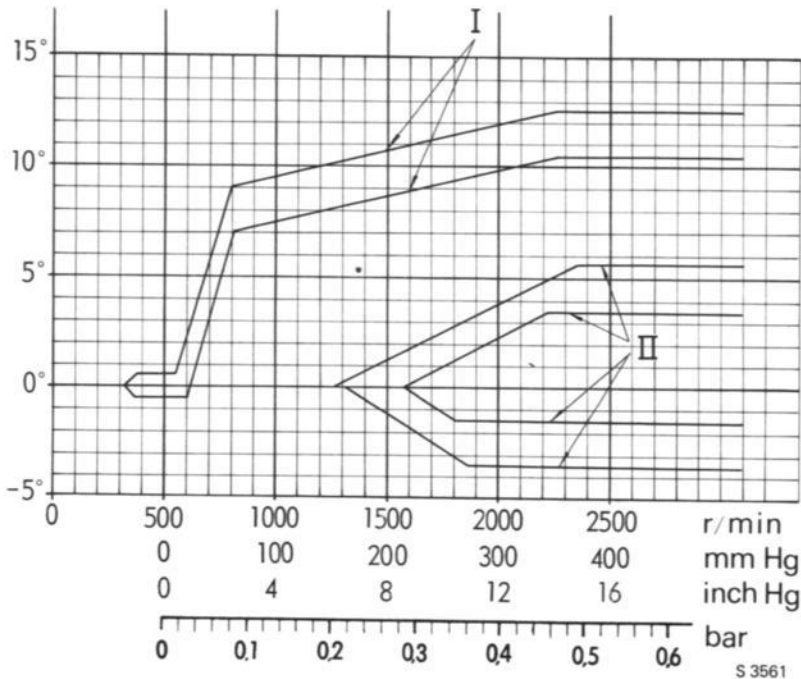

S 3561

CENTRIFUGAL AND VACUUM ADVANCE DISTRIBUTOR
0 231 167 039

Dwell angle $50 \pm 2^\circ$

Contact pressure 4.9–6.2 N (17–22 oz, 500–630 p)

I = Centrifugal advance r/min = Distributor rev./min
II = Vacuum advance mm/Hg } = Underpressure
 inchHg }

LIGHTING

Headlights

General

The headlights are mounted in retractable holders which are carried in plastic bushings mounted in the engine hood. The right and left headlight inserts are identical and can thus be fitted on either side of the car without alteration. With regard to the electrical connections, see the diagram in section 300 "Description".

If for some reason the pullrod for the headlights is out of operation, the headlights can be folded up in the following ways:

1. Model 1970: The headlights can be folded up from the outside of the car.
2. As from model 1971: Open the engine hood lid and pull that part of the mechanism in which the pullrod is attached backwards. Note! The headlights can not be folded up from the outside of the car.

Replacement of Sealed Beam headlight insert

Removal

1. Insert a screwdriver in the hole in the lower edge and prize the headlight frame loose.
2. Back off and remove the three screws holding the retaining ring and remove the ring.
3. Detach the contact piece and take away the insert.

Installation

1. Press the contact piece on and fit the new insert, making sure that the guide lugs fit into the respective grooves.
2. Refit the retaining ring.
3. Check the setting and adjust as necessary.
4. Hook the frame on at the top. Insert a screwdriver in the hole in the lower edge. Press the holding spring upwards, at the same time pressing the frame into position.

An other alternative: Hook the frame on at the top and then knock it into position, using a wooden-tool against the lower part of the frame.



INSTALLING THE HEADLIGHT INSERT

Alignment of headlights

1. Remove the headlight frames. See "Replacement of headlight insert".
2. Align roughly in the vertical direction by slackening the screw (1) and adjusting the headlights with the retaining bar (2). After aligning, tighten the screw.



HEADLIGHT ADJUSTMENT

1. Screw
2. Arm for headlight mechanism

3. With the headlights fully raised, i.e. with the pullrod in its rear limit position, make two marks on the pullrod, one at a distance of 0.2 in. (5 mm) and the other at a distance of 0.4 in. (10 mm) from the instrument panel. See fig.

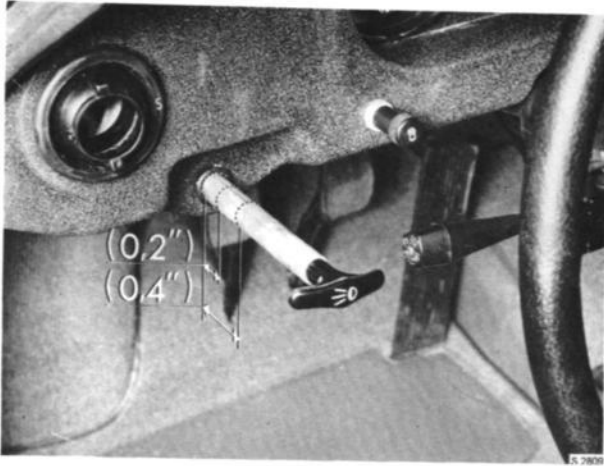

MARKS ON THE PULLROD FOR ADJUSTMENT OF HEADLIGHT TENSION

4. Slacken the lock nut and adjust the tensioning screw on the left headlight so that it comes up against the stop when the pullrod is 0.2 in. (5 mm) from the limit position, i.e. at the first mark. Tighten up the lock nut.

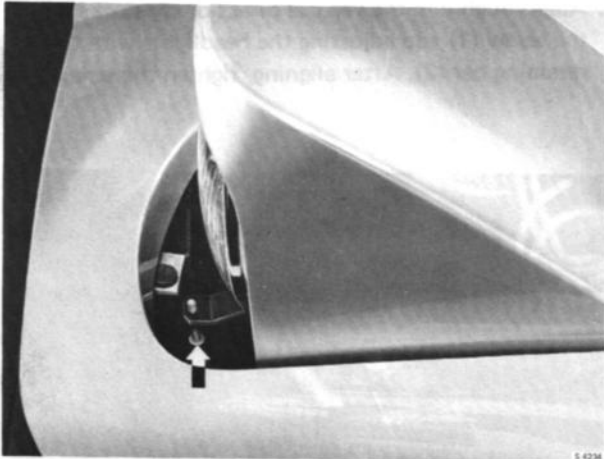

HEADLIGHT TENSIONING SCREW

5. Adjust the right headlight in the same way, but so that the screw comes up against the stop when the pullrod is 0.4 in. (10 mm) from the limit position, i.e. at the second mark.
These adjustments impart a certain amount of tension to the headlights so that they do not vibrate in the raised position. The reason why the right headlight is to be given more tension than the left one is that compensation must be provided for the turning which occurs in the intermediate shaft.
6. Pull the pullrod all the way out and align finely both vertically and horizontally with the headlight adjusting screws. See fig.
7. Refit the headlight frames. See "Replacement of headlight insert".



SCREWS FOR HEADLIGHT ADJUSTMENT

1. Hole for removal and fitting of headlight frame
2. Screw for horizontal adjustment
3. Screw for vertical adjustment

Headlight holders

Removal

1. Take off the hood. See Group 8.
2. Detach the intermediate shaft by backing off and removing the two through-going screws.
3. Remove the taper pins from the headlight shafts (three on each headlight), thus enabling the shafts to be withdrawn and the headlight holders to be lifted off.
If the bushings are to be renewed, the adhesive must be ground off first.

Installation

1. Fit new bushings, if necessary, attaching them with a suitable adhesive compound, e.g. Plastic Padding. Smear all sliding surfaces with a lubricant of the molybdenum sulphide type (Molykote).
2. Refit the headlight holders and shafts.
3. Refit the hood.
4. Align the headlights.

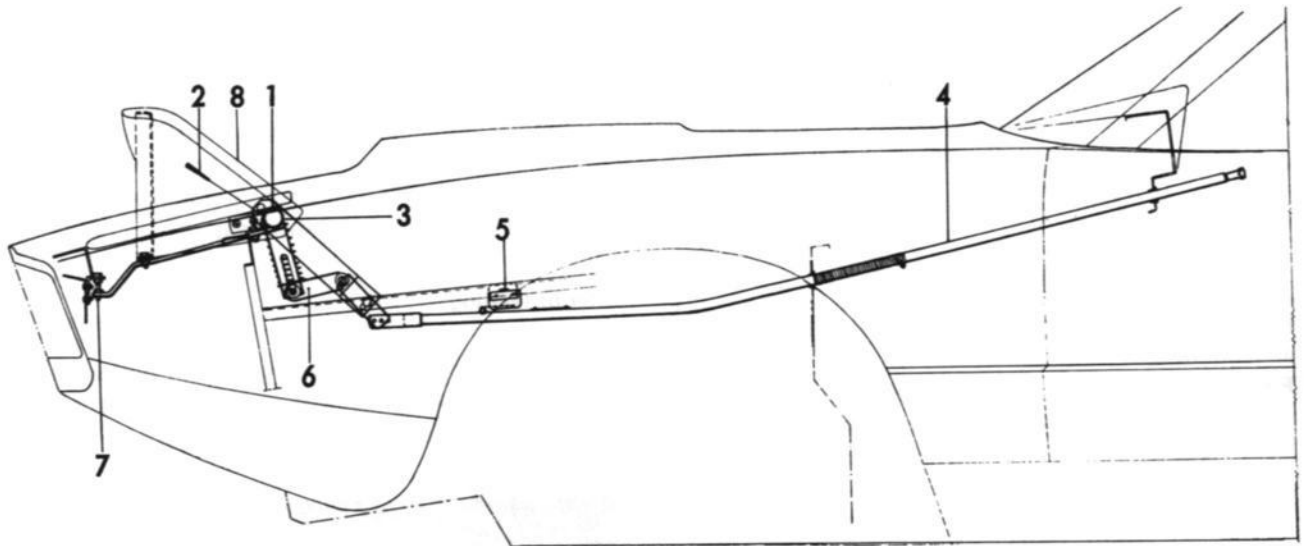

HEADLIGHT HOLDER

1. Intermediate shaft
2. Taper pin
3. Bushing
4. Pullrod
5. Microswitch
6. Headlight mechanism
7. Tensioning screw
8. Headlight holder

Parking, stop and back-up lights, direction indicator lights (flashers), number-plate light and side-position lights

General

The front parking lights are mounted on the hood and combined with the direction-indicator flashers. The tail lights incorporate in the same mountings parking lights

as well as lamps for the stop and back-up lights, number-plate light and direction-indicator flashers. Side-position lights are provided on both sides at front and rear, the bulbs for these being connected in parallel with the parking lights. The stop-light switch is hydraulic and is located on the secondary circuit of the master brake cylinder. The switch for the back-up light is located on the gear-lever housing.

Changing bulbs for flashers and for back-up, parking, stop and number-plate lights

1. Back off and remove the two retaining screws and remove the lens together with its screws.



CHANGING BULBS, FRONT

2. Take the bulb out of its bayonet socket.
3. Clean the bulb socket and lens, taking care to remove all impurities.
4. Fit the new bulb. Make sure that good contact is obtained, particularly at the earth connection.
5. Refit the lens.



CHANGING BULBS, REAR

Changing bulbs for side position lights

Changing is done in the same way as described in the above section, the difference being that in this case the lens and frame are removed by moving the rubber moulding aside with a small screwdriver. See fig.

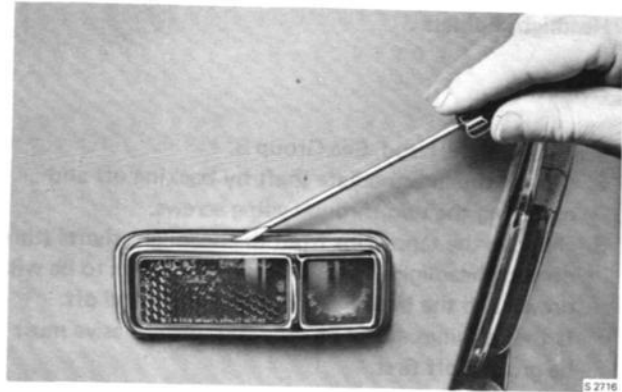

CHANGING BULBS

Changing bulbs

1. Remove the lamp unit by prizing carefully at one edge with a screwdriver. The bulb can then be removed.
2. Press the new bulb in, making sure that the two fastenings close snugly, so that the bulb sits firmly.
3. Refit the lamp unit by inserting one edge in the hole and then pressing in the other edge.

Interior lighting

The map reading light (located below the glove compartment) is switched on by the door contact or by the switch on the lamp. see fig.

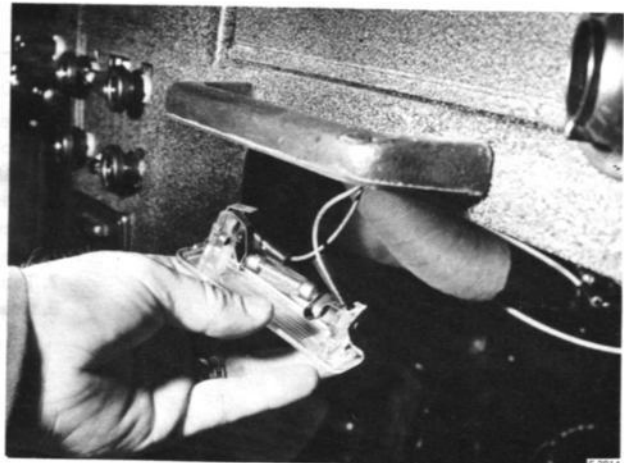

CHANGING BULB, INTERIOR LIGHT

Instrument lighting

Changing bulbs

1. Back off and remove the four screws holding the instrument insert. Pass the speedometer cable in from the direction of the engine compartment. Remove the instrument insert.
2. Remove the bulb holder concerned and fit a new bulb. Refit the holder.
Note that the bulb holders in the fuel and temperature gages are fitted with a bayonet socket.
3. Reinstall the instrument insert. Pull the speedometer cable out into the engine compartment.

DIRECTION INDICATORS

General

The direction indicators consist of flashing lights at front and rear. At the front, the flashers are combined with the parking lights and flash with orange light. At the rear, separate lamps are provided for the flashers.

The flasher unit, which is installed under the instrument panel, is combined with a control relay which indicates, by means of green warning lamps on the instrument panel, that the direction indicator is on and that both lamps are working.

If one of the flashers fails to operate, the warning lamp will not glow and the remaining light will flash more rapidly. If the flasher unit is in good condition and correct bulbs are fitted, the direction indicator will flash at the rate of 60–120 flashes per minute.

The flasher unit is not adjustable. If the other parts of the direction-indicating system (switch, wires and lamps) are in good order, erratic flashing must be due to a faulty flasher unit. In these circumstances, a new flasher unit must be fitted.

NOTE

The fitting of bulbs with incorrect ratings will result in abnormal flashing frequency.

The clearance between the return yoke and the projection on the directional indicator switch should be 0.008–0.024 in. (0.2–0.6 mm) with the switch at neutral. Adjust by inserting shims between the switch and the column stand.

NOTE

Fit the return yoke so that its center line coincides with the center axis of the switch housing, when the wheels are straight ahead.

CAUTION

Make sure that the return yoke is not fitted so far forward that it can damage the switch for the windshield wipers (model 1970).

HORNS, SIGNALLING DEVICE

General

The horns are mounted at the front under the hood and are accessible for remove from underneath. One high-pitched and one low-pitched horn are harmonized to give a high-penetration signal.

If the horns produce a discordant sound, localize the defective horn and adjust by turning the contact screw marked with red paint on the rear of the horn until a pure note is obtained.

Signalling device

Model 1970:

The horns are operated with the lever for the windshield wipers. To sound the horn, move the lever towards the steering wheel.

As from model 1971:

The horns are operated with a contact in the safety pad of the steering wheel.

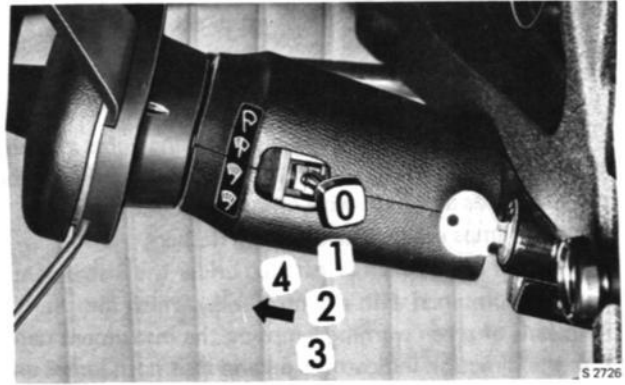

WINDSHIELD WIPER/WASHER CONTROL LEVER AND SIGNAL HORN LEVER, MODEL 1970

- 0. Neutral position
- 1. Windshield wipers, half speed
- 2. Windshield wipers, full speed
- 3. Windshield wipers, full speed + washer
- 4. Signal horn (works in positions 0-3)

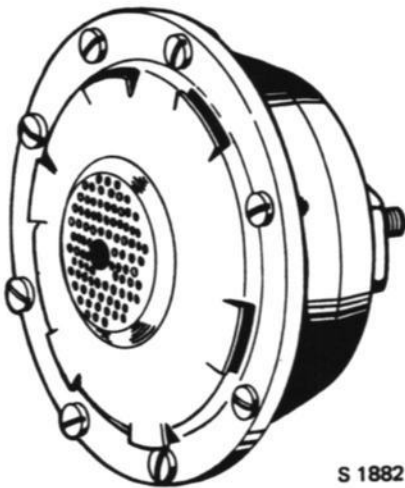

HORN

S 1882

WINDSHIELD WIPERS AND WASHERS

On model 1970, both windshield wipers and windshield washers are of the same type as in the Saab V4. The wiper shafts are, however, attached in a different way and the washer is fitted with two double jets.

As from model 1971, the windshield wipers are changed. The wiper motor is moved to the right hand side of the engine compartment and the motion are transmitted from the motor to the wiper spindles via a reversible cable. This cable actuates gear wheels on the wiper spindles.

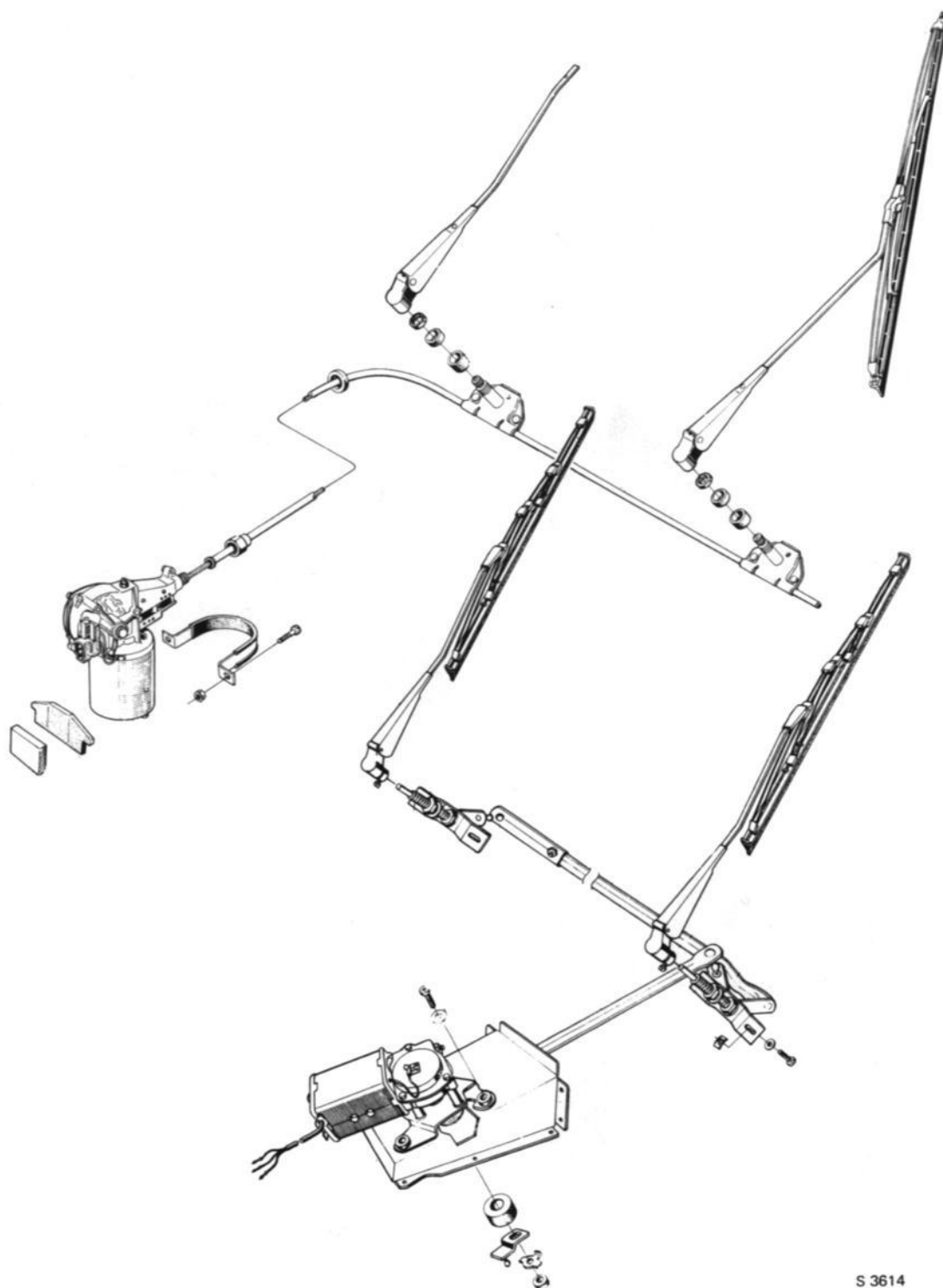

S 3614

WINDSHIELD WIPER MOTOR WITH LINKAGE

Windshield wiper motor, model 1970

Removal

1. Take off the hood. See Group 8.
2. Back off and remove the three wiper-motor retaining screws and pull the cable splice apart.
3. Bend the ball joint for the wiper-mechanism linkage open. The motor can now be removed. The ball joint is accessible through a hole above the headlight operating rod at the dash panel. See fig.

Reinstall in the reverse sequence. Note the method for installation of the hood in group 8.

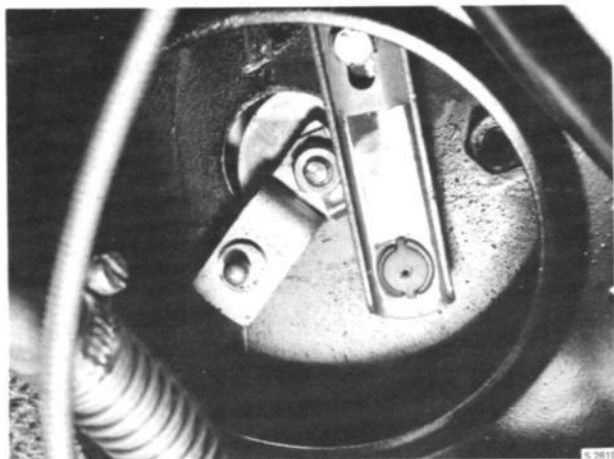

THE WIPER-MECHANISM LINKAGE HAS BEEN DISCONNECTED

Adjustment of windshield wiper parking position

1. Slacken the three screws securing the gearbox cover so that the cover can be turned.
2. Adjust to the wanted parking position and tighten the cover.



ADJUSTMENT OF PARKING POSITION

Wiper mechanism, model 1970

Removal

1. Remove the wiper arms and the nuts of the wiper shafts.
2. Unfasten the instrument insert and pull it out slightly so as to provide access to the mechanism.

NOTE

Notice the way in which the mechanism is turned. It must be installed so that both wiper shafts rotate in the same direction.

3. Back off and remove the four retaining screws for the mechanism and collect the flat nuts. Divide the mechanism in the ball joints and pull it out under the instrument panel. See fig.

Reinstall in the reverse sequence.

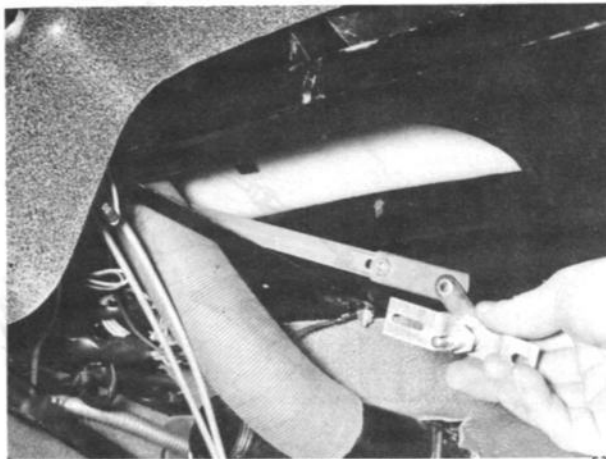

REMOVAL OF WIPER MECHANISM

Windshield wiper motor, as from model 1971

Removal

1. Remove the hood. See Group 8.
2. Remove the wiper arms.
3. Remove the nine self-tapping screws retaining the heater box cover.
4. Disconnect the electrical cables from the wiper motor.
5. Remove the clamp that is fixing the motor to the chassis frame. The nuts for the clamp can be reached from the outside of the wheel housing.
6. Lift the motor and back off the nut that is fixing the wire tube to the motor. Turn the motor and remove it together with the wire.

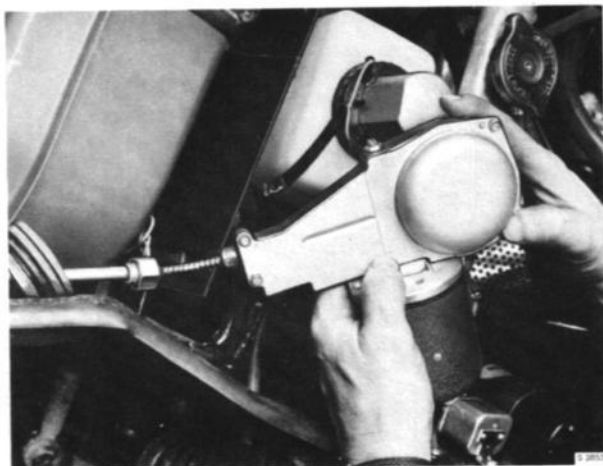

REMOVAL OF WIPER MOTOR, AS FROM MODEL 1971

Installation

1. Fit the wire of the new wiper motor in the tube. It might be necessary to turn the motor and the wire somewhat anticlockwise to get the wire to enter the gears on the wiper spindles. Tighten the nut for the tube. Put the motor in place and at the same time fit the grommet on the heater box.
2. Fit the clamp for the motor. Do not forget the wooden spacer and the rubber pad between the motor and the wheel housing. The rubber pad should be placed at the motor.

3. Connect the cables on the motor. See sketch. Check the function of the motor.

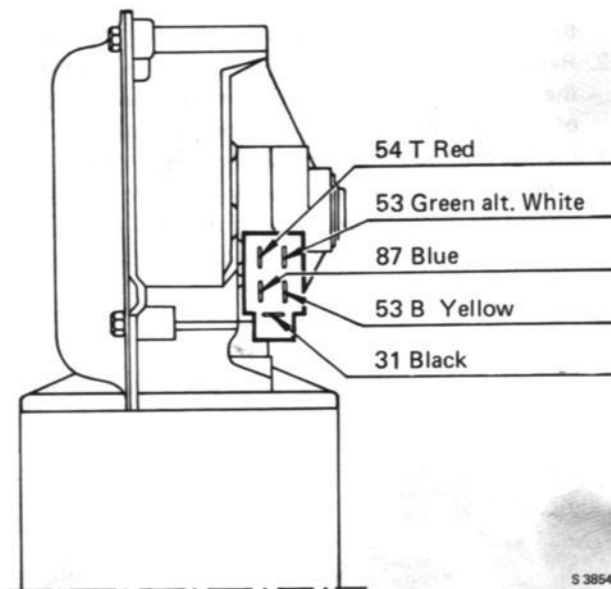

CONNECTION POSITIONS OF WIPER MOTOR

4. Check that the grommet for the wire tube is correctly fitted in the fire wall and fit the cover on the heater box.
5. Fit the wiper arms in positions where the best swept area is achieved.
6. Install the engine hood as described in Group 8.

Wiper mechanism, as from model 1971

Removal

1. Remove the wiper arms. Unscrew the nuts and remove the rubber rings on the wiper spindles.
2. Release the instrument panel and pull it out so that the wiper mechanism will be accessible. Detachment of the instrument panel is described in Chapter 8.
3. Loosen the two nuts on the wiper spindle of the right hand side. Push both the wiper spindles from outside and divide the outer cable casing from the spindle on the right hand side. Then the mechanism can be removed from the cable.

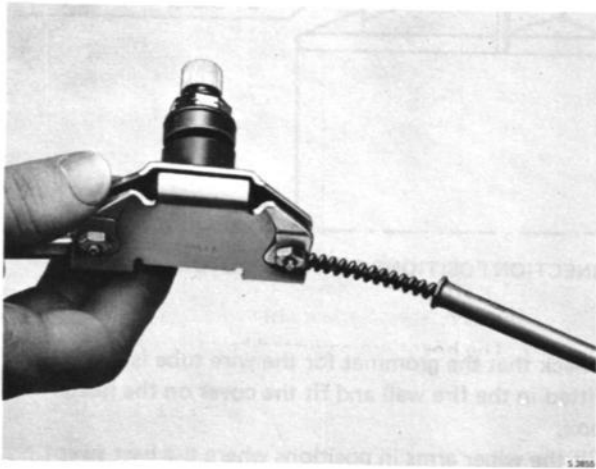

REMOVAL OF WIPER MECHANISM

Installation

Reinstall in reverse order.

ELECTRICAL CONTROLS AND SWITCHES

General

The ignition lock is located on the steering column stand and is combined with the starter switch and steering wheel lock.

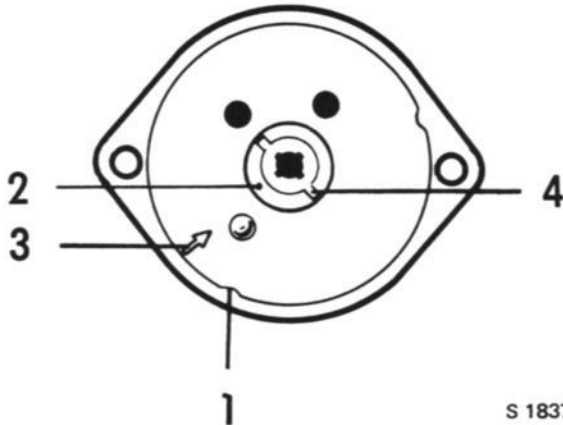

IGNITION AND STARTER SWITCH

1. Locating stud
2. Setting mark
3. Marking arrow
4. Cogwheel mounting slot

The ignition and starter switch is secured to the steering wheel lock by means of two screws. During removal and installation, the steering wheel lock must be in the locked position and the switch in the position shown in the figure. (The ball in the hole nearest the arrow.) Note the locating lug.

The switch for the ventilation fan has two positions, viz. full speed and half speed. It is located on the instrument panel by the heater controls. The switch actuates an operating relay, through which the fan motor is started. The relay is mounted on the left side under the instrument panel. See fig.

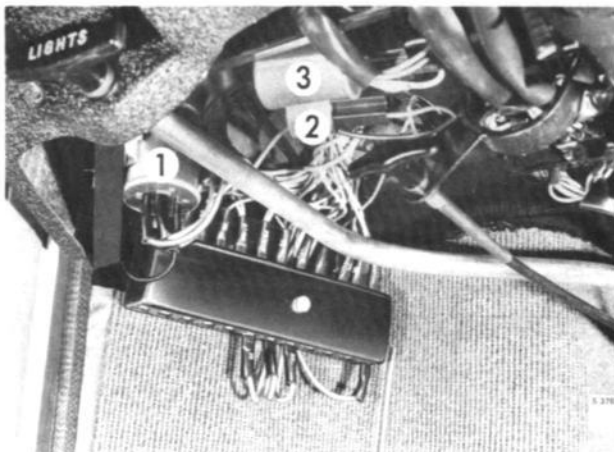

LOCATION OF RELAYS AND BUZZER

1. Relay for heater fan
2. Buzzer
3. Direction indicator relay

The headlights are switched on with a microswitch and relays. The microswitch is actuated by the pullrod for headlight operation. See section 300 "Description". Switching between high beam and dipped beam is achieved by lifting the lever for the direction-indicator switch, thereby actuating a dimmer relay which dims the lights. The intensity of the instrument lighting can be regulated with a rheostat located on the left side of the instrument panel. There is a separate pull-out switch for the parking lights in the middle of the instrument panel.

Mounted on the instrument panel, close to the heater controls, is a switch for extra lights. These light only when the headlights are switched on at high beam. The relay is mounted in the engine compartment. See also section 300 "Description".

An automatic reset switch under the steering wheel controls the current to the direction indicators (flashers). The hazard warning signal switch is located in the middle of the instrument panel. When the button is pulled out, all the direction indicator lights and the corresponding warning lamps flash simultaneously.

The windshield wipers, electric windshield washer and horns are operated with a lever located to the right of the steering column. This lever has four positions: neutral, windshield wipers low speed, windshield wipers high speed and windshield wipers high speed plus windshield washer. The horns are activated by moving the lever towards the steering wheel.

The stop-light switch is actuated by the pressure of the brake fluid and completes the circuit to the stop-lights when a certain brake pressure is reached.

The switch is mounted on the secondary circuit of the master brake cylinder.

Brake warning system

Faults in the brake system in the form of leakage or poorly adjusted rear brakes are indicated by a brake warning light located in the speedometer. The light is turned on by a switch located by the brake pedal. After remedying the fault which caused the warning light to glow, the switch is reset by pulling it out. The clearance between the brake-pedal lever and the switch should be 0.79 ± 0.02 in. (20 ± 0.5 mm).

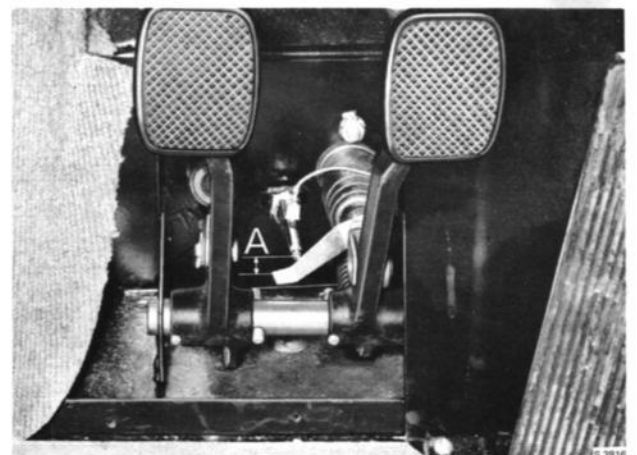

LOCATION OF BRAKE-WARNING LIGHT SWITCH
A = 0.79 ± 0.02 in. (20 ± 0.5 mm)

Back-up light switch

The switch is located on the gear lever housing and is actuated by the gear lever. To adjust, slacken the lock nut and screw the switch in or out as applicable. If this adjustment possibility is insufficient, the reason may be that the gear lever housing is mounted too far forward. If so, slacken the four retaining screws and adjust the position.

NOTE

The switch must not be adjusted so far as to cause it to be actuated by the gear lever in the 2nd gear position.

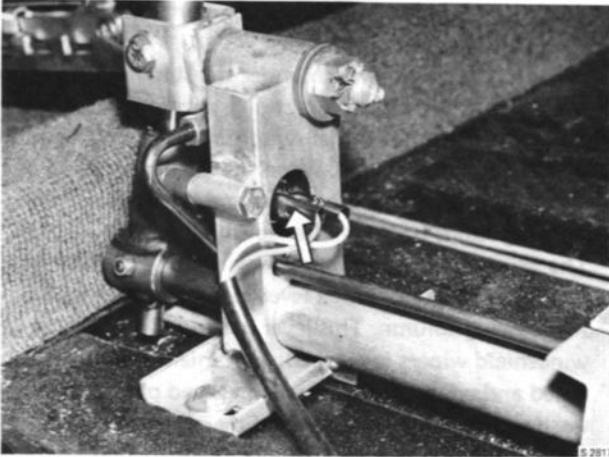

LOCATION OF BACK-UP LIGHT SWITCH

Seat belt warning system model 1972-1973

The following components are included in the warning device:

Buzzer	- Below instrument panel
Warning light	- On instrument panel
Seat contact	- In passenger seat
Micro switch	- Gear lever
Retractor contacts	- In front seat retractors

Seat belt/ignition interlock system as from model 1974

The following components are included in the above system:

Buzzer	- Below instrument panel
Warning light	- On instrument panel
Starter relay	- Under instrument panel
Seat contact	- Driver's seat
Seat contact	- Passenger seat
Belt contact	- Driver's latch mechanism
Belt contact	- Passenger's latch mechanism
Handbrake contact	- Handbrake
Logic relay	- Under instrument panel

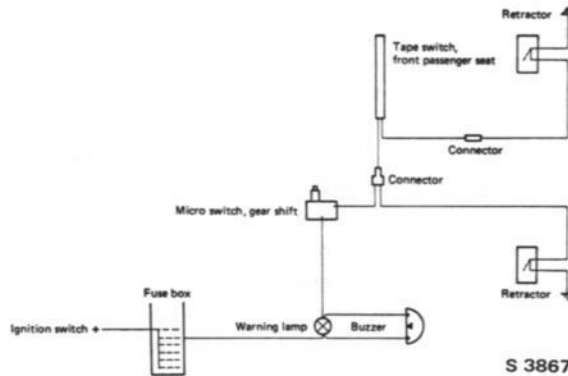

WIRING DIAGRAM, SEAT BELT WARNING SYSTEM, MODEL 1972-1973

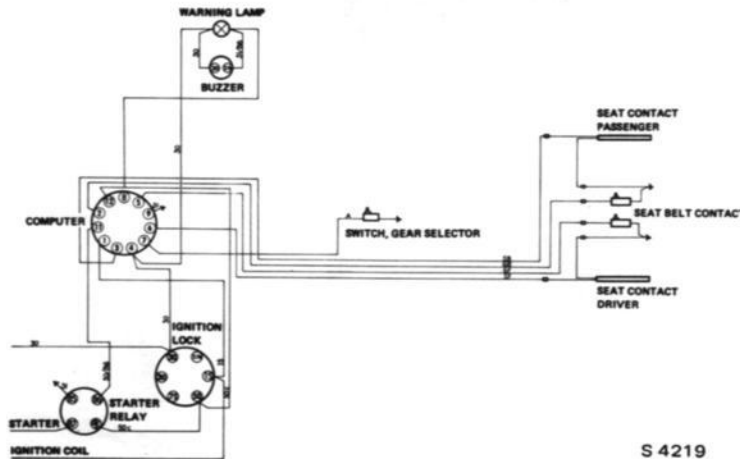

WIRING DIAGRAM, SEAT BELT WARNING SYSTEM, AS FROM MODEL 1974

CHANGING THE OIL-PRESSURE SWITCH

Removal

1. Disconnect lead.
2. Unscrew and remove oil-pressure switch 1.06 in. (27 mm) wrench opening.

Installation

NOTE

Smear sealing compound on threads before installing.

1. Screw in oil-pressure switch and tighten to 12–15 Nm (1.2–1.5 kpm, 9–10 ft.lb.).
2. Connect lead.

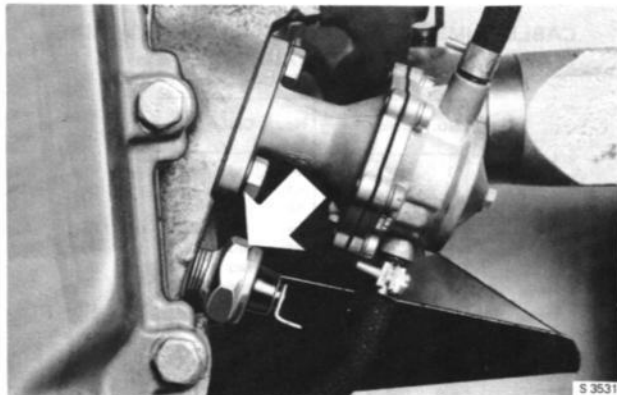

OIL-PRESSURE SWITCH

CHANGING THE ELECTRICAL TEMPERATURE TRANSMITTER

Removal

1. Drain off coolant.
2. Disconnect lead.
3. Unscrew transmitter 1/2 in. wrench opening.

Installation

NOTE

Smear sealing compound on threads before installing.

1. Screw in transmitter.
2. Connect lead.
3. Fill cooling system with coolant.
4. Run engine until hot and check temperature gauge reading.
5. Check coolant level and replenish if necessary.

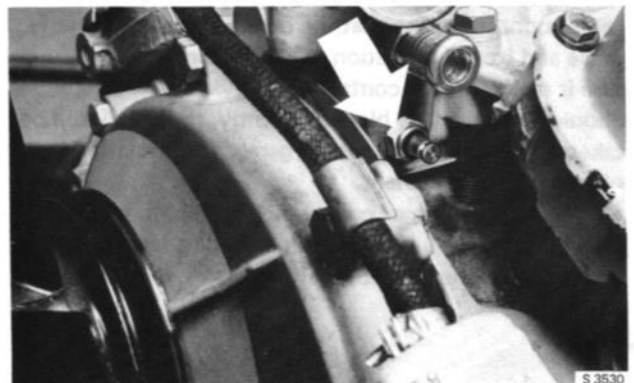

TEMPERATURE TRANSMITTER

WIRING AND FUSES

Wiring

The cables and wires lead the current from the battery or generator to the various items of consumer equipment. In order to protect the wiring and to reduce the risk of shorting, the wires are gathered into harnesses wherever possible, i.e. a number of individually insulated wires are carried in an enclosing plastic sheath.

Provided that the wiring is fitted in strict accordance with the different wiring diagrams reproduced further on, removal and installation of wires and cables should not present any difficulties. The individual wires and cables in each harness are color-marked for ready identification in accordance with the numbers given in the diagrams and accompanying tables.

The cable connections are made with AMP connectors and thus require no soldering.

Make sure that all cables and wires are properly connected, thus avoiding unnecessary voltage drops and flashovers.

Fuses

The electrical system is provided with 16 fuses. The fuses are located in two fuse boxes, one under the engine hood lid on the left-hand wheel housing and one under the instrument panel at the left-hand door. The electric units protected by each fuse are indicated inside the box lids.

If a fuse is still intact after a fault has been found, this may be because of a poor contact in the holder or at a cable connection. See that the connections are properly made and free of oxidation. When fitting a new fuse, be sure it makes proper contact.

Should the same fuse blow frequently, the car should be taken immediately to a service garage for insulation tests of cables and equipment.

NOTE: A fuse does, of course, not protect that part of the circuit which lies between it and the power supply at damage on the insulation of the cables, the contact points, etc.

If frequent fuse burn-out occurs, and if damaged insulation is suspected, check the insulation of the harnesses by testing. Bear in mind, however, that fuses will not burn out if a short occurs before the fuse.

When installing new wiring, always check positively that the rating of the selected wires and cables is adequate to cope with the load involved, and make sure that the cables are properly protected where they pass through panels and at clamps.

IMPORTANT

When fitting a new fuse, take pains to secure good contact.

If wire fracture is suspected, check that the fuse concerned makes good contact before taking any further steps. Use a voltmeter for this check: the maximum permissible voltage drop is 0.1 V.

CABLE NUMBERS AND COLOR CODES TO WIRING DIAGRAM ON THE NEXT PAGE

No.	Color	Area mm ²	No.	Color	Area mm ²
1	red	0,75	54i	red	0,75
3	brown	0,75	54i	red	1,5
5	brown	0,75	54r	red	0,75
8	yellow	0,75	54s	red	0,75
13	brown	0,75	54t	red	0,75
14	grey	0,75	54w	red	0,75
15	red	0,75	55	white	0,75
30	red	0,75	56	grey	1,5
30	red	1,5	56a	blue	0,75
30	red	2,5	56a	white	1,5
30	red	4,0	56b	red	1,5
30a	red	1,5	56b	yellow	1,5
30i	red	1,5	56f	blue	0,75
30/49	red	0,75	56h	yellow	0,75
31	black	0,75	56s	yellow	0,75
31	black	1,5	56v	blue	0,75
31b	brown	0,75	58	green	0,75
31b	brown	1,5	58	green	1,5
49	green	0,75	58b	green	0,75
49a	grey	0,75	61	red	0,75
49b	blue	0,75	67s	red	1,5
49p	yellow	0,75	67s	black	1,5
49+	red	0,75	86	red	0,75
50	red	0,75	FB	brown	0,75
51	brown	0,75	LS	black	0,75
53a	green	0,75	S	red	0,75
53b	grey	0,75	S	brown	0,75
53f	yellow	0,75	T58	grey	0,75
54	red	1,5			

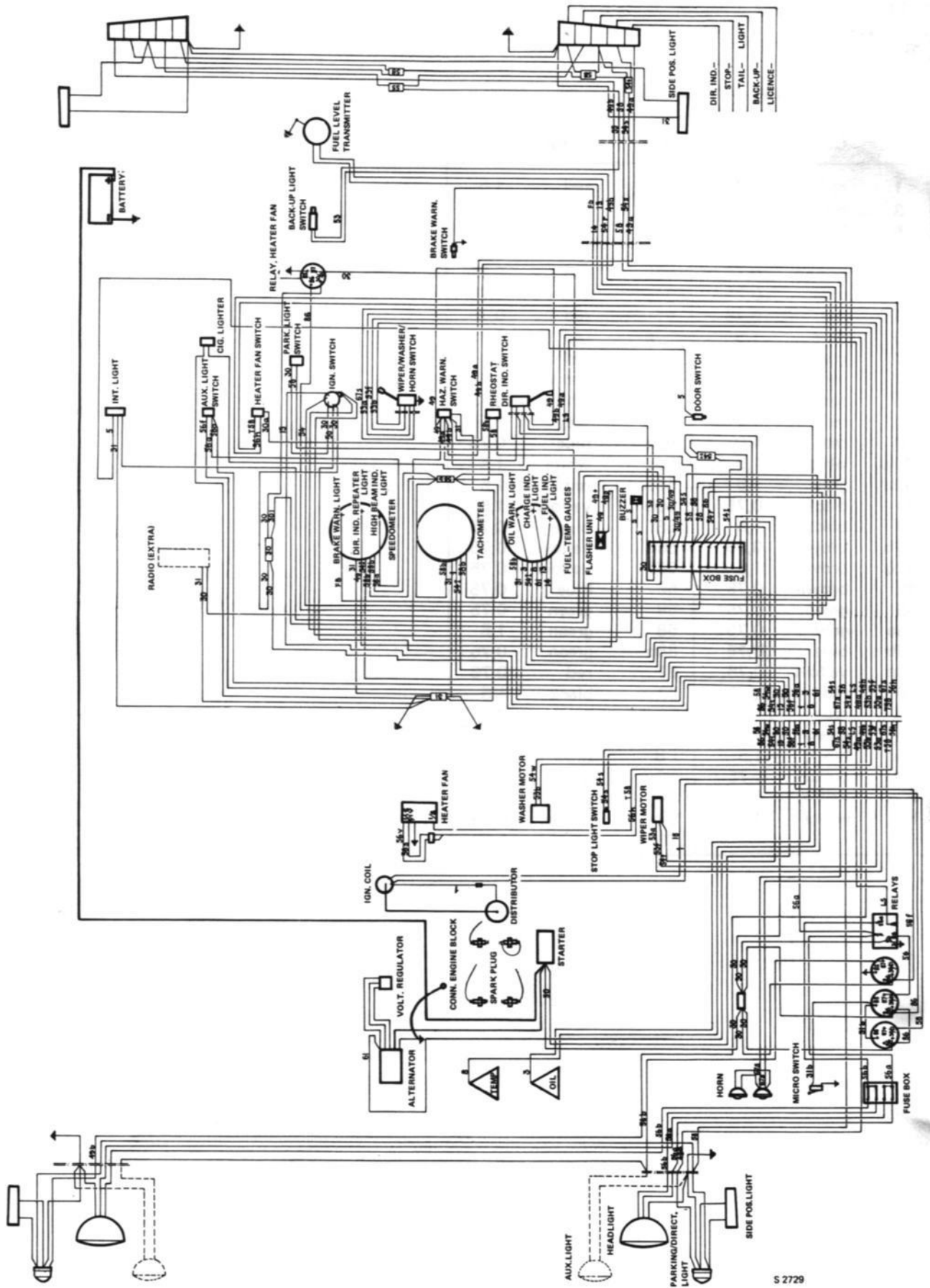

WIRING DIAGRAM, MODEL 1970

S 2729

Cable numbers and color codes

No.	Color	Area mm ²	No.	Color	Area mm ²
1	red	0,75	54	red	1,5
3	brown	0,75	54c	grey	0,75
5	brown	0,75	54i	white	0,75
8	yellow	0,75	54i	white	1,5
13	brown	0,75	54k	red	0,75
14	grey	0,75	54r/86	white	0,75
15	red	0,75	54r/86	red	0,75
30	blue	1,5	54s	red	0,75
30	green	0,75	54t	red	1,5
30	red	0,75	54w	brown	0,75
30	red	1,5	55	white	0,75
30	red	2,5	56	grey	1,5
30	red	4,0	56a	blue	0,75
30a	white	1,5	56a	white	1,5
30l	grey	1,5	56b	red	1,5
31	black	0,75	56b	yellow	1,5
31	black	1,5	56f	blue	0,75
31b	brown	0,75	56h	yellow	0,75
31b	brown	1,5	56s	yellow	0,75
49	brown	0,75	56v	blue	0,75
49	green	0,75	58	green	0,75
49a	grey	0,75	58	green	1,5
49b	blue	0,75	58b	green	0,75
49p	yellow	0,75	61	red	0,75
50	red	0,75	67	black	1,5
50	red	1,5	86	blue	0,75
53	green	0,75	87	blue	0,75
53a	black	1,5	FB	brown	0,75
53b	yellow	0,75	LS	black	0,75
53b	yellow	0,75	S	red	0,75
53c	white	0,75	S	yellow	0,75
			T58	grey	0,75

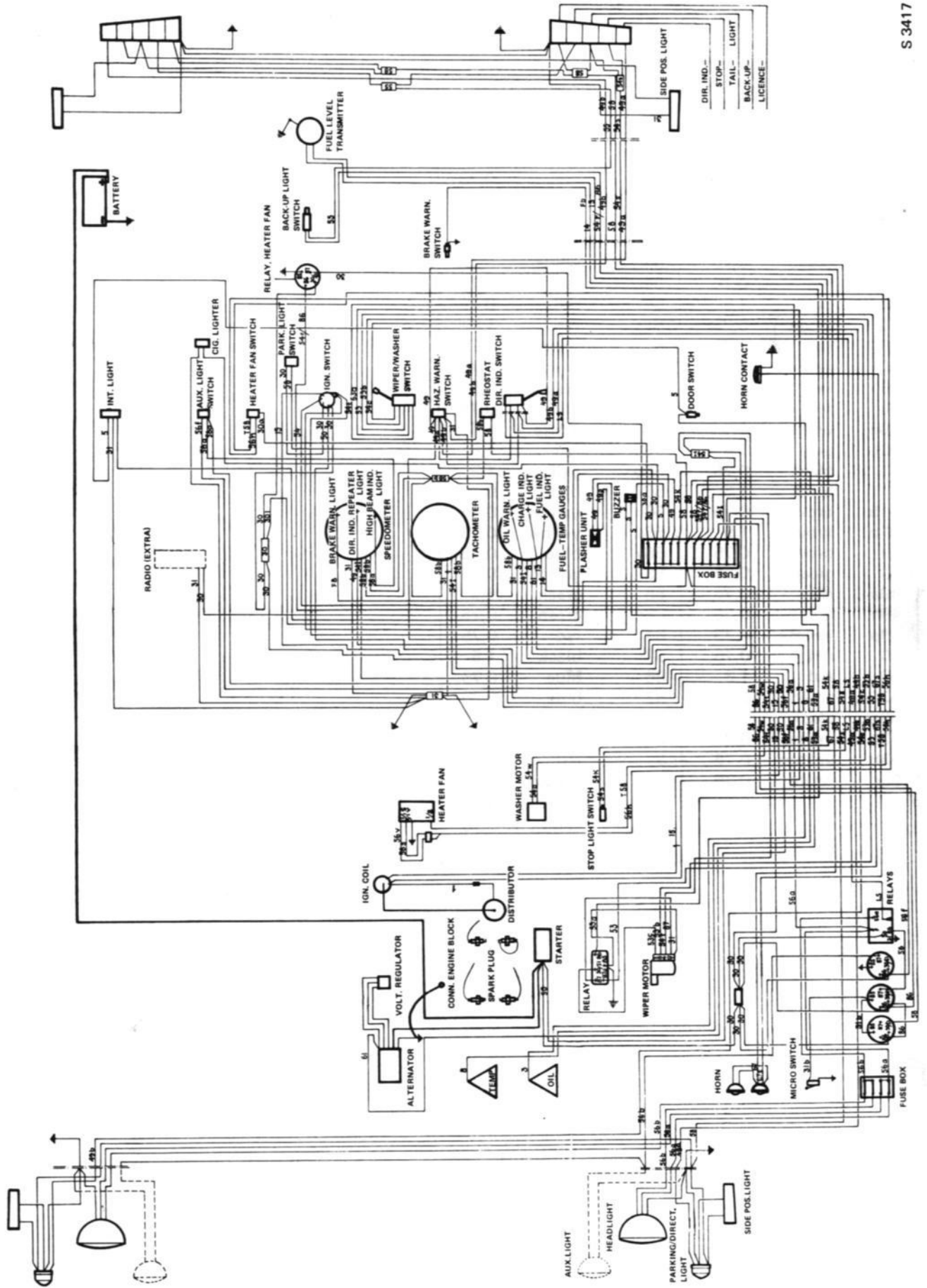

Cable numbers and color codes

No.	Color	Area mm ²	No.	Color	Area mm ²
1	red	0,75	54	red	1,5
3	brown	0,75	54c	grey	0,75
5	brown	0,75	54i	white	0,75
8	yellow	0,75	54i	white	1,5
13	brown	0,75	54k	red	0,75
14	grey	0,75	54r/86	white	0,75
15	red	0,75	54r/86	red	0,75
30	blue	1,5	54s	red	0,75
30	green	0,75	54t	red	1,5
30	red	0,75	54w	brown	0,75
30	red	1,5	55	white	0,75
30	red	2,5	56	grey	1,5
30	red	4,0	56a	blue	0,75
30a	white	1,5	56a	white	1,5
30l	grey	1,5	56b	red	1,5
31	black	0,75	56b	yellow	1,5
31	black	1,5	56f	blue	0,75
31b	brown	0,75	56h	yellow	0,75
31b	brown	1,5	56s	yellow	0,75
49	brown	0,75	56v	blue	0,75
49	green	0,75	58	green	0,75
49a	grey	0,75	58	green	1,5
49b	blue	0,75	58b	green	0,75
49p	yellow	0,75	61	red	0,75
50	red	0,75	67	black	1,5
50	red	1,5	86	blue	0,75
53	green	0,75	87	blue	0,75
53a	black	1,5	FB	brown	0,75
53b	yellow	0,75	LS	black	0,75
53b	yellow	0,75	S	red	0,75
53c	white	0,75	S	yellow	0,75
			T58	grey	0,75
			B1	yellow	0,75
			B2	red	0,75

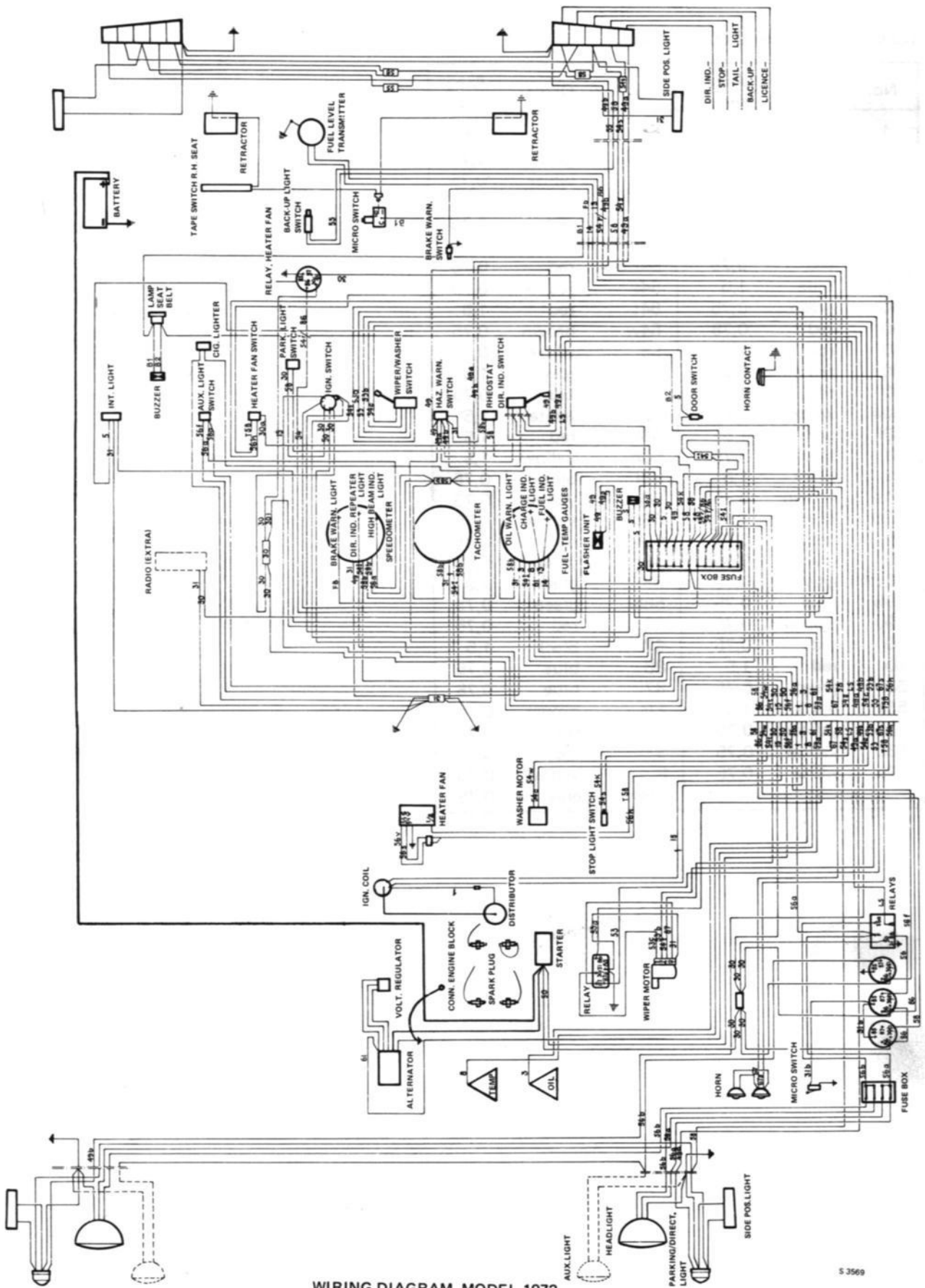

WIRING DIAGRAM, MODEL 1972

53569

Cable numbers and color codes

No.	Color	Area mm ²	No.	Color	Area mm ²
1	red	0,75	54	red	1,5
3	brown	0,75	54c	grey	0,75
5	brown	0,75	54i	white	0,75
8	yellow	0,75	54i	white	1,5
13	brown	0,75	54k	red	0,75
14	grey	0,75	54r/86	white	0,75
15	red	0,75	54r/86	red	0,75
30	blue	1,5	54s	red	0,75
30	green	0,75	54t	red	1,5
30	red	0,75	54w	brown	0,75
30	red	1,5	55	white	0,75
30	red	2,5	56	grey	1,5
30	red	4,0	56a	blue	0,75
30a	white	1,5	56a	white	1,5
30l	grey	1,5	56b	red	1,5
31	black	0,75	56b	yellow	1,5
31	black	1,5	56f	blue	0,75
31b	brown	0,75	56h	yellow	0,75
31b	brown	1,5	56s	yellow	0,75
49	brown	0,75	56v	blue	0,75
49	green	0,75	58	green	0,75
49a	grey	0,75	58	green	1,5
49b	blue	0,75	58b	green	0,75
49p	yellow	0,75	61	red	0,75
50	red	0,75	67	black	1,5
50	red	1,5	86	blue	0,75
53	green	0,75	87	blue	0,75
53a	black	1,5	FB	brown	0,75
53b	yellow	0,75	LS	black	0,75
53b	yellow	0,75	S	red	0,75
53c	white	0,75	S	yellow	0,75
			T58	grey	0,75

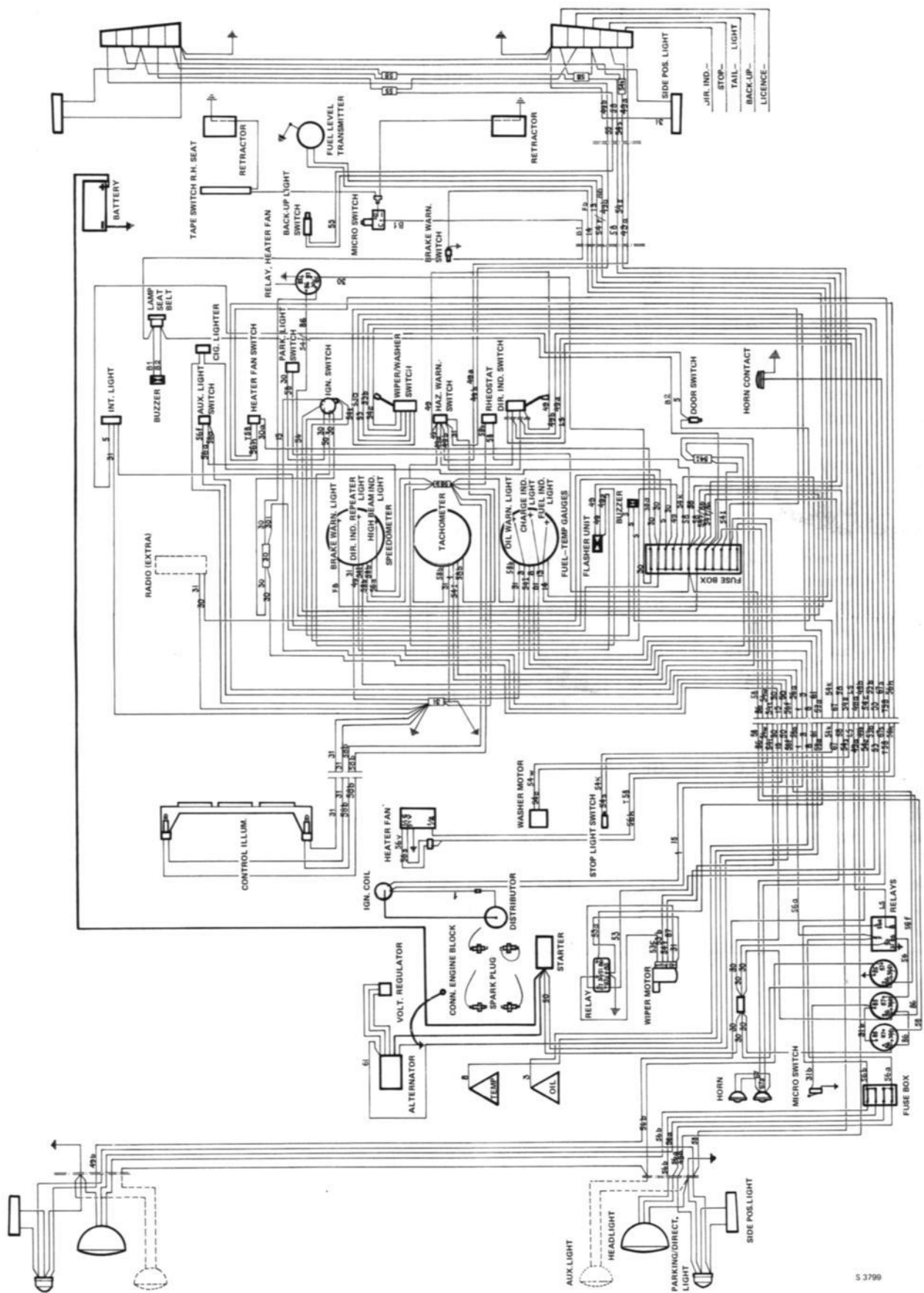

WIRING DIAGRAM, MODEL 1973

Cable numbers and color codes

No.	Color	Area mm ²	No.	Color	Area mm ²
1	red	0,75	54k	red	0,75
3	brown	0,75	54r/86	white	0,75
5	brown	0,75	54r/86	red	0,75
8	yellow	0,75	54s	red	0,75
13	brown	0,75	54t	red	1,5
14	grey	0,75	54w	brown	0,75
15	red	0,75	55	white	0,75
30	blue	1,5	56	grey	1,5
30	green	0,75	56a	blue	0,75
30	red	0,75	56a	white	1,5
30	red	1,5	56b	red	1,5
30	red	2,5	56b	yellow	1,5
30	red	4,0	56f	blue	0,75
30a	white	1,5	56h	yellow	0,75
30l	grey	1,5	56s	yellow	0,75
31	black	0,75	56v	blue	0,75
31	black	1,5	58	green	0,75
31/86	black	0,75	58	green	1,5
31b	brown	0,75	58b	green	0,75
31b	brown	1,5	61	red	0,75
49	brown	0,75	67	red	1,5
49	green	0,75	67s	black	1,5
50	red	0,75	86	blue	0,75
50	red	1,5	87	blue	0,75
50/86	brown	0,75	A	green	0,75
50c	red	0,75	FB	brown	0,75
53	green	0,75	GB	white	0,75
53a	black	1,5	GF	yellow	0,75
53b	yellow	0,75	LS	black	0,75
53b	yellow	1,5	S	red	0,75
53c	white	0,75	S	yellow	0,75
54	red	1,5	SB	green	0,75
54c	grey	0,75	SF	blue	0,75
54i	white	0,75	T58	grey	0,75
54i	white	1,5			

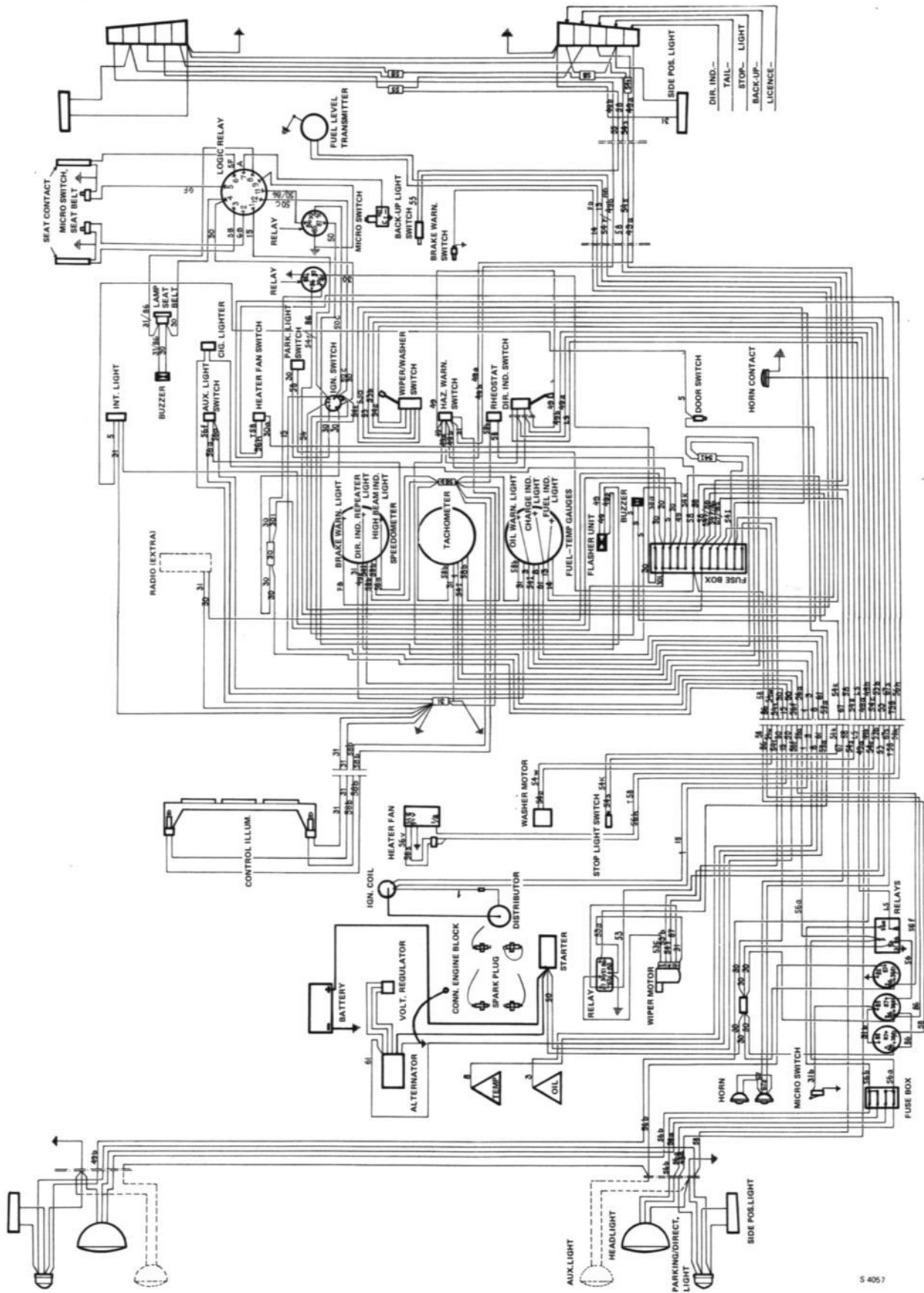

WIRING DIAGRAM MODEL 1974

○

○

○

○

CONTENTS

400	Description
411	Clutch*
412	Clutch operation
432	Gear operation
	Gear box
470	Removal and installation
	Gear box
471	Disassembly and reassembly*
473	Differential and pinion-ring gear*
475	Universal joints and shafts*

*) See Service Manual Saab V4.

○

○

○

○

DESCRIPTION

General

The transmission in the Sonett III is largely identical with that in the Saab V4, the differences being that the gearbox has a final gear, pinion and crown wheel, with the ratio 9:42 and that gear shifting is done with a floor gear lever located between the seats. The clutch, universal joints and drive shafts are, however, the same.

Clutch

General

Clutch operation is hydraulic and comprises a master cylinder connected to the clutch pedal and a slave cylinder that actuates the clutch.

The master cylinder is connected to a reservoir which must be kept filled with brake fluid up to the level mark on the outside of the reservoir.

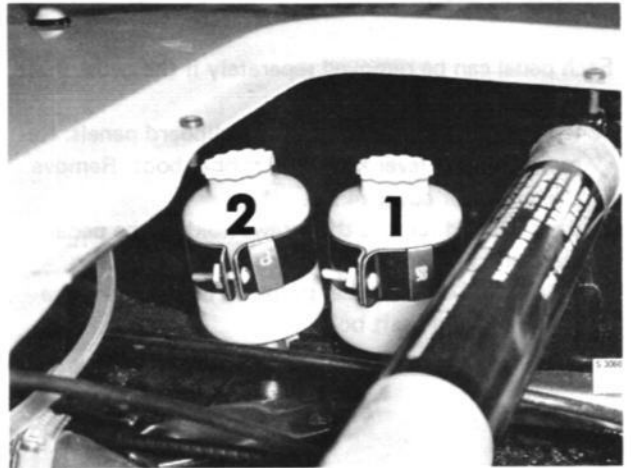

1. Brake fluid container
2. Clutch fluid container

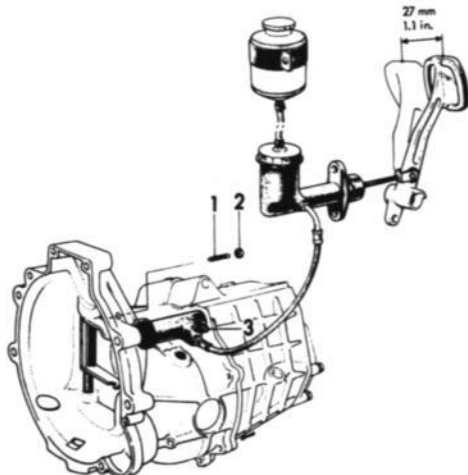

CLUTCH PEDAL WITH ADJUSTMENT MECHANISM

1. Adjusting screw
2. Lock nut
3. Bleeder screw

Gearbox

The Sonett III is equipped with the same type of 4-speed gearbox as the Saab V4. See Service Manual for Saab V4.

CLUTCH OPERATION

Pedal stand

Removal of pedals

Each pedal can be removed separately if the pedal shaft is removed.

1. Remove the floor mat and the wallboard panels. Remove the gear lever knob and rubber boot. Remove the gear lever cover (4 screws).
2. Back off and remove the screws holding the pedal plate and lift out the two parts of the latter.
3. Release the clutch-pedal push-rod by removing the cotter pin and shaft bolt.

4. Release the return springs of the brake pedal and clutch pedal.

5. Strike out all slotted pins and pull out the pedal shaft.

6. Detach the push-rod from the rubber boot, thereby enabling the brake pedal to be separated from the master cylinder. When the pedal is then lifted out, it will be accompanied by the push-rod.

Reassembly takes place in the reverse sequence.

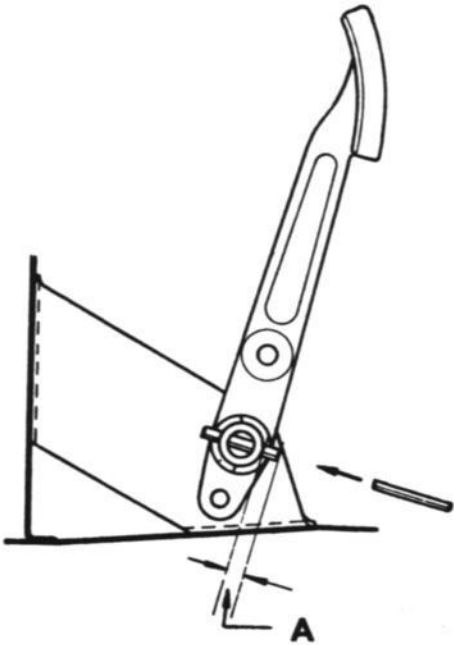

SLOTTED PINS, PEDAL SHAFT
A = $8 \pm 1,5$ mm

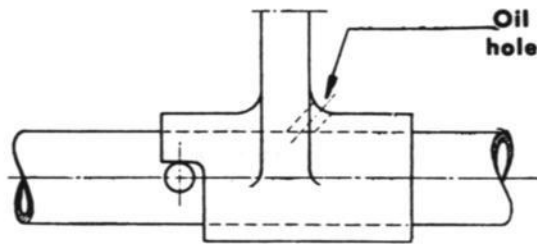

S 1366
OIL HOLE, CLUTCH- AND BREAK PEDAL

Adjustment of clutch-pedal free movement

The clearance between release bearing and release plate is gradually decreased by wear on the clutch facings. Adjust the clutch pedal free movement with the screw on the clutch housing. This screw is located on the opposite side in relation to the slave cylinder. The free movement is increased by slackening the screw (turning to the left). The clearance is checked by pressing the slave cylinders connection to the clutch arm. A movement of 0.16" (4 mm) here, gives the correct clutch clearance. See fig.



ADJUSTING THE CLUTCH CLEARANCE
A = 0.16" (4 mm)

Master cylinder

General

The master cylinder is a cast unit containing the cylinder and fluid reservoir.

The cylinder consists of a housing of light alloy with a surface-polished bore and with an inner assembly, made up to the push-rod, cupped washer, lock ring, piston, end seal, piston seal, spring retainer, piston-return spring, valve spacer, elastic washer, valve spindle and valve seal.

The open end of the cylinder is protected by a rubber dust cap.

When the piston returns to the position of rest, the valve which affords a seal in the bottom of the cylinder during disengagement opens. When the valve is open the fluid is able to pass freely from the slave cylinder to the reservoir.

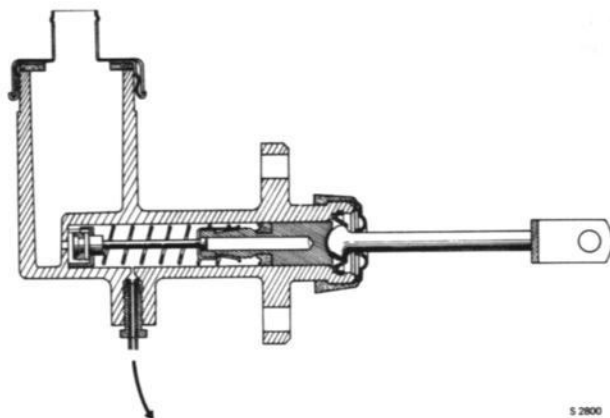

MASTER CYLINDER, CUT-AWAY VIEW

As from chassis No. 97725000193:

Fluid container with internal thread for cover

Removal of master cylinder

1. Take out the floor mat and the wallboard panel on the left side. Remove the left pedal plate.
2. Release the clutch-pedal push-rod by removing the cotter pin and shaft bolt.
3. Take off the left front wheel.
4. Detach the hose from the slave cylinder (or remove the entire slave cylinder). Undo the filler hose connection to the cover.
5. Back off and remove the two retaining screws holding the master cylinder to the dash panel and lift the cylinder out.

After reinstalling, which is done in the reverse sequence, bleed the system.

Disassembly

Ease the rubber dust cap back and remove the lock-ring, using long-nosed pliers. It is now possible to remove the push-rod and the cupped washer. Removal of the push-rod reveals the piston and its seal. Remove the complete piston assembly. The assembly can be disassembled by lifting the retainer spring leaf over the tongued end of the piston. Carefully take the piston seal off the piston and remove the end seal.

Push down the piston-return spring, thus enabling the valve spindle to slide through the key-shaped hole in the retainer so that the spring lets go. Remove the valve spacer, taking care not to damage the elastic washer located under the valve head. Remove the seal from the valve head.

Examine the cylinder bore and if it not scored or distorted, and feels smooth to the touch, new seals may safely be fitted. If, on the other hand, the slightest doubt is entertained about the condition of the bore, a new cylinder should be fitted.

If the old seals are loose on the piston and too big, contamination by mineral oil may be suspected. This is the commonest cause of cylinder trouble, and often sufficient pains are not taken to prevent it. Seals of natural rubber are highly susceptible, and even minute quantities of oil can gradually cause considerable swelling. If the slightest trouble in this respect is suspected, fit new seals throughout the system and flush the system clean with pure brake fluid.

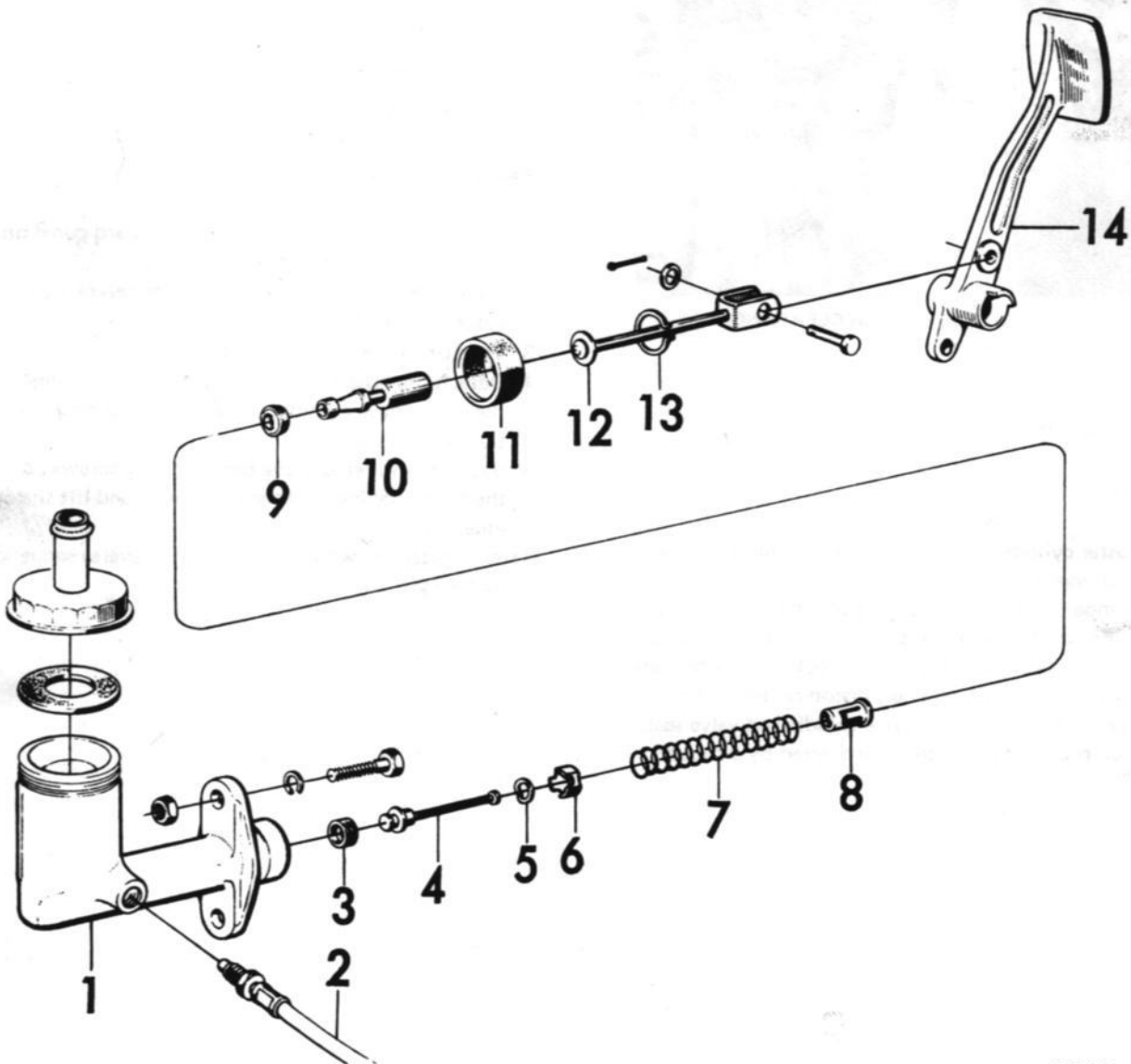

S 2775

MASTER CYLINDER, DISASSEMBLED

- | | |
|---------------------|---------------------------------|
| 1. Cylinder housing | 8. Spring retainer |
| 2. Hose | 9. Seal |
| 3. Seal | 10. Piston |
| 4. Rod | 11. Rubber dust cap |
| 5. Elastic washer | 12. Push-rod with cupped washer |
| 6. Valve spacer | 13. Lock ring |
| 7. Spring | 14. Clutch pedal |

Reassembly

Fit the seal with its flat side properly located on the valve head. Then put on the elastic washer with its cupped side facing the lower side of the valve head, retaining it in position by means of the valve-spacer, the legs of which are turned towards the valve seal. Refit the piston return spring, centering it on the washer, insert the spring retainer in the spring and press down until the valve spindle bottoms through the key-shaped hole. At the same time, check that the spindle is correctly located in the middle of the retainer. Check that the spring is still centered on the spacer. Fit a new seal on the piston with its flat side turned towards the seat of the piston.

Insert the small end of the piston in the retainer until the retainer spring leaf engages the piston tongue. Press the retainer leaf fully home.

Lubricate the piston thoroughly with Wakefield/Girling Rubber Grease 3 and refit the assembly in the cylinder bore, valve end first, at the same time easing the piston seal lips slowly into the bore.

Remount the push-rod in the cylinder, followed by the lock-ring, placing this in the milled groove in the cylinder body. Replace the rubber dust cap or, if it is damaged, fit a new one.

Slave cylinder

General

The slave cylinder is secured to the clutch housing by means of a screw. The inner assembly comprises the push-rod, lock-ring, piston and piston spring. The open end of the cylinder is protected by a rubber dust cap and a bleed nipple is located in the bleeder opening.

Removal

1. Disconnect the hose and pump out the fluid into a clean vessel.
2. Back off the retaining screw(s) for the cylinder.
3. Separate the cylinder from the push-rod and clutch housing.

Installation

1. Locate the slave cylinder on the clutch housing and pass the push-rod through the hole in the rubber dust cap.
2. Refit and tighten the retaining screw(s).
3. Reconnect the hose.
4. Bleed the system.

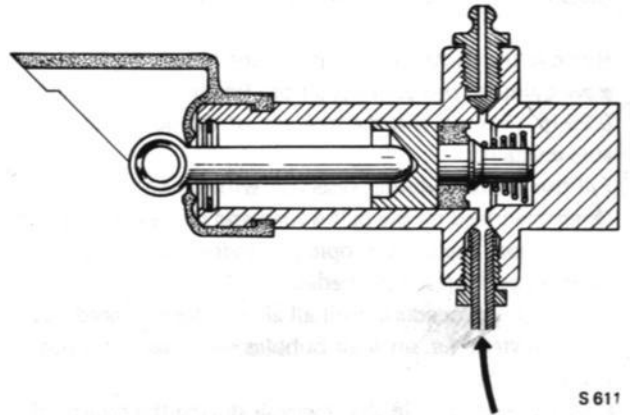

SLAVE CYLINDER, CUT-AWAY VIEW

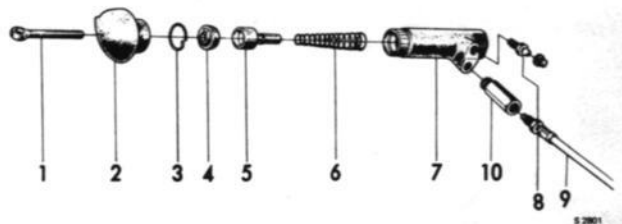

SLAVE CYLINDER, DISASSEMBLED

- | | |
|--------------------|--------------------|
| 1. Push-rod | 6. Spring |
| 2. Rubber dust cap | 7. Cylinder body |
| 3. Lock ring | 8. Bleeder screw |
| 4. Seal | 9. Hose |
| 5. Piston | 10. Distance piece |

Disassembly

Ease the dust cap back and remove the lock-ring, using long-nosed pliers. The piston with seal attached can now be removed, followed by the spring. Examine the cylinder bore and if it is not scored or distorted, and feels smooth to the touch, a new seal can be fitted. If, on the other hand, the slightest doubt is entertained about the condition of the bore, a new cylinder should be fitted.

Reassembly

Reassembly by following in reverse sequence the instructions given for "Disassembly", taking pains to lubricate the seal and to pack the rubber boot with Wakefield/Girling Rubber Grease No. 3. Always lubricate the cylinder bore with brake fluid when reassembling this unit.

Bleeding the master and slave cylinders

Remove the protective cap from the bleed nipple on the slave cylinder and connect a hose (inside diameter approx. 0.25 in. (6 mm). Dip the free end of the hose into a suitable container.

Fill the master cylinder reservoir with brake fluid. Open the bleed nipple half a turn and depress the clutch pedal. Close the bleed nipple just before the bottom position and release the pedal.

Repeat this procedure until all air has been cleared out of the system, i.e. until air bubbles no longer flow out from the hose.

Check the oil level in the reservoir during the course of this work.

Refit the protective cap on the bleed nipple.

Release bearing

Removal and installation of release bearing

1. Lift the engine out of the car as described in Section 201.
2. Turn the clutch lever forward and remove the two spring clips retaining the release bearing in the fork. See fig.
3. Remove the release bearing.
After changing the bearing, reinstall in the reverse sequence.

IMPORTANT

Always make sure that the spring clips are correctly located.

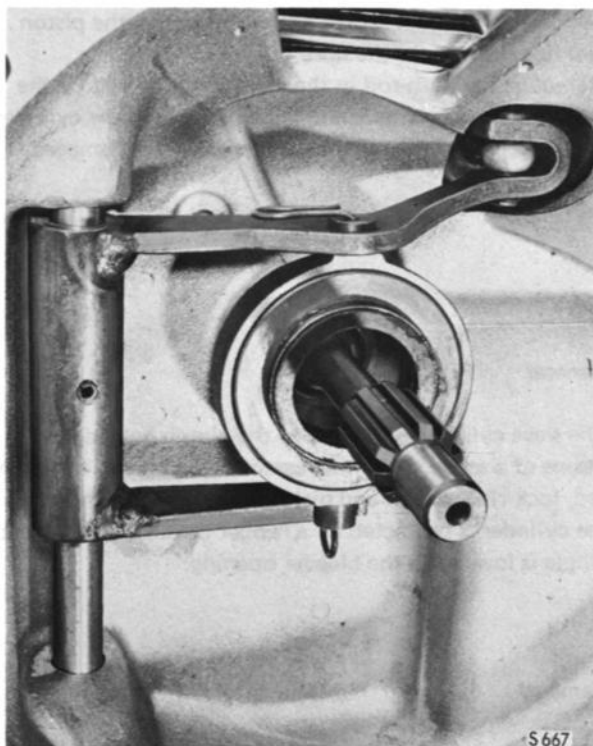

RELEASE BEARING ATTACHMENT

GEAR OPERATION

General

Gear shifting is done with a floor-type gear lever located between the seats. The gear-operating mechanism consists otherwise of a gear-lever housing secured to the floor between the seats and of a rod which transmits the movement from the gear lever to the gearbox.



GEAR POSITIONS

Removal of gear-lever housing

1. Take out the floor mat and the wallboard panels.
2. Remove the gear-lever knob and rubber boot.
3. Remove the gear-lever cover by backing off and removing the four screws at the points of attachment to the floor.
4. Release the taper pin of the gear shift rod joint by moving the nut over to the opposite end of the pin. Then release the pin with the aid of the nut. Pull the gear shift rod apart.
5. Detach the cables to the back-up light switch.
6. Remove the gear-lever housing by backing off and removing the four screws which hold the housing to the floor.

Reassembly takes place in the reverse sequence.

Adjustment of gear positions

Checking

Put the gear lever in neutral position. Move the lever to the left till you feel that it is touching the spring for the reverse gear catch. Move the lever $\sim 1/2''$ (measured at the knob) further to the left. Move the lever backwards to engage 2nd gear. At this check with the lever pressed $\sim 1/2''$ to the left, the 2nd gear and not the reverse gear must be engaged. Start the engine for checking. Repeat the procedure to make sure that the reverse gear will not be engaged.

Adjustment

If the reverse gear is engaged when checking as described above, the cover must be removed and the adjusting nut for the reverse gear spring must be backed off until the 2nd gear will engage.

Note that the adjusting nut must not be screwed out so far that there will be difficulties to engage 1st and 2nd gear when shifting normally. Do not forget to tighten the lock nut.

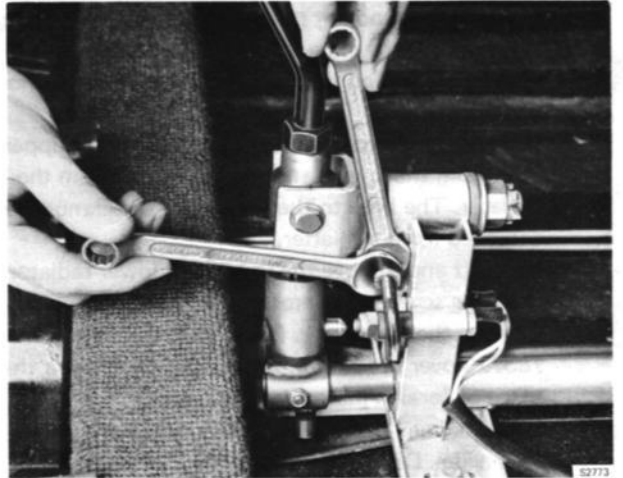

ADJUSTING THE NUT FOR THE REVERSE GEAR SPRING

3rd and 4th gear:

Adjustment is done by means of the adjusting screw on the left hand side. 3rd and 4th gears shall engage easily when the heel of the fork bolt comes up against the adjusting screw.

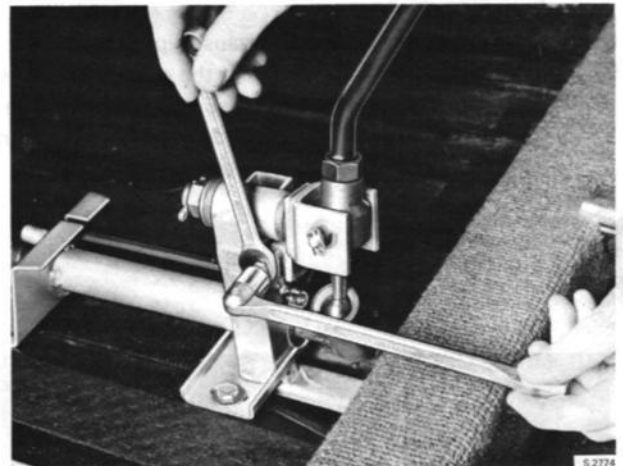

ADJUSTMENT OF 3RD AND 4TH GEAR POSITIONS

REMOVAL AND INSTALLATION OF ENGINE BODY

Removal of engine

If work is to be done on the transmission unit only, the entire power unit must be lifted out. The engine is then separated from the transmission unit.

1. Disconnect the battery earth cable from the battery.
2. Jack up the car and place trestles in the front edges of the sills.
3. Remove the hood. See Group 8.
4. Drain off the coolant through the radiator draining tap. Remove the expansion tank cap and open the venting nipples on the heat exchanger and thermostat housing.
5. Disconnect the coolant hoses, detaching the upper hose from the engine and the lower one from the radiator. The hose to the expansion vessel must be detached from the latter.
6. Back off and remove the upper and lower radiator retaining screws and remove the radiator.
7. Remove the air cleaner. Place a plastic cover No. 783729 over the carburetor air inlet to prevent the entry of foreign matter into the engine.
8. Disconnect all hoses and cable connections from the engine. Disconnect the battery cable from the screws in the dividing surface between the engine and the transmission unit.
9. Disconnect the engine side braces at the two retaining screws in the cylinder head.
10. Remove the throttle control by unfastening the support from the induction pipe and pulling out the connection link to the throttle valve shaft.
11. Remove the two front engine cushions, working from above.
12. Back off and remove the exhaust pipe flange nuts at the cylinder heads. Separate the exhaust systems at the joints behind the exhaust manifold. Remove the spacers at the cylinder heads, and lower the front exhaust system as far as possible.

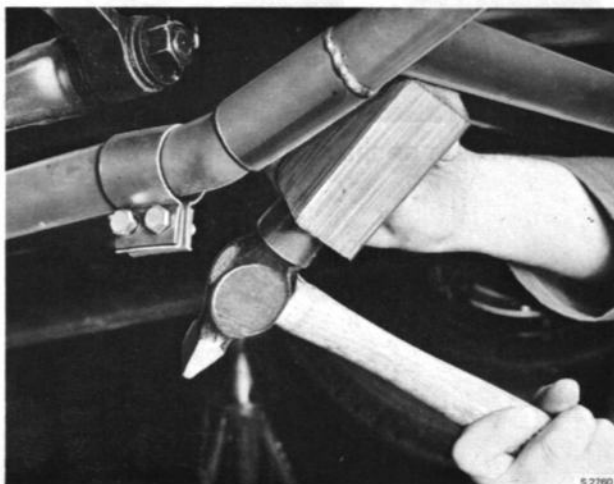

SEPARATING THE EXHAUST SYSTEMS

13. Disconnect the freewheel control and the speedometer cable from the gearbox.
Back off and remove the clutch cylinder retaining screw and hang the cylinder up in a suitable position.
14. Remove the floor mat and the wallboard panels. Remove the gear lever knob and the rubber boot. Remove the transmission casing (4 screws).
15. Remove the right pedal plate to provide access to the rear engine bracket and the front gear shift rod joint. Remove the center screw from the engine bracket.
16. Remove the front taper pin of the gear shift rod joint by moving the nut over to the opposite end of the pin. The pin can then be removed by means of the nut.
Open up the gear shift rod.



OPENING UP THE GEAR SHIFT ROD

17. Undo the large clamps round the rubber boots on the inner universal joints.
To facilitate lifting and to avoid damaging the alternator and cooling fan, these items should be removed.
18. Attach the lifting device, tool No. 786202, see Fig., to a suitable hoist and lift the engine carefully about 2 in. (50 mm). Pull the transmission pin out of the rear engine bracket.

If the rear engine bracket is stuck, it can be knocked off with the aid of a suitable arbor, see Fig.

NOTE

The blow must be directed against the engine bracket and not against the transmission pin.

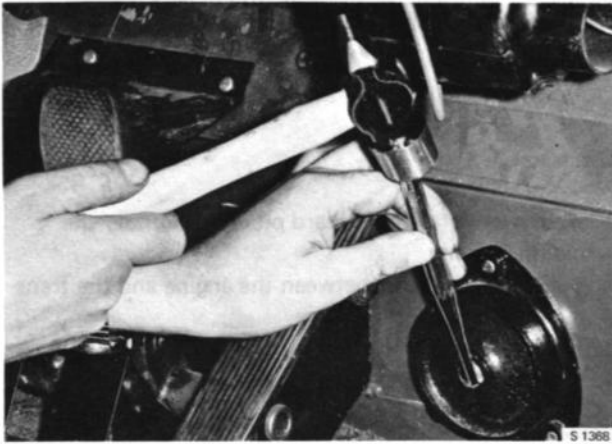

THE REAR ENGINE BRACKET CAN BE KNOCKED OFF WITH A HAMMER AND AN ARBOR

19. Open up the inner universal joints, first on the right side and then on the left. Do this with the T-shaped pieces of the drive shafts located vertically and with the engine unit pushed over as far as possible in the opposite direction. Fit protective covers 732373 in the rubber boots and 783846 on the inner drivers.
20. Lift the power unit out of the engine compartment. Make sure that the throttle control, expansion tank, etc., do not get damaged.
21. Clean the power unit and separate the engine from the gearbox if necessary.

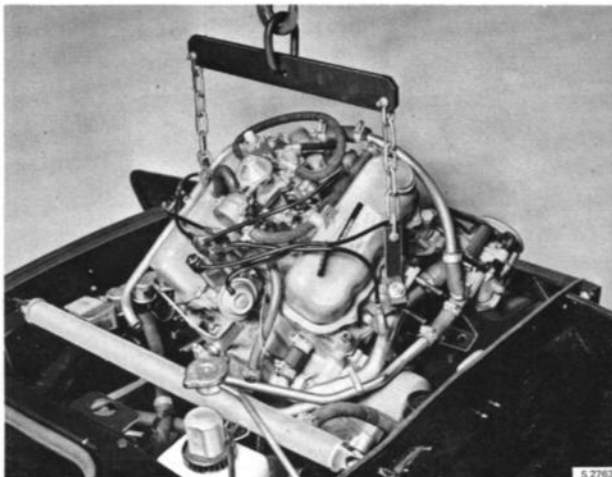

REMOVAL AND INSTALLATION OF POWER UNIT WITH LIFTING HOOK 786202

Installation

1. Check that the inner universal joints are filled with the appropriate grease. The joints must be completely filled with grease upon assembly.
2. Lift the power unit into the engine compartment, using lifting device No. 786202.
3. Lower the power unit so far that the engine brackets are about 2 in. (50 mm) from the engine cushions.
4. Place the T-pieces of the drive shafts in the inner

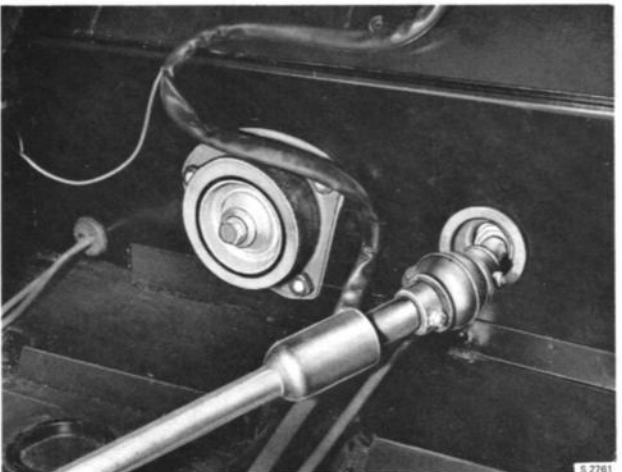

FITTING THE LIMITING WASHER

- universal joints. Do this with the T-pieces located vertically and with the power unit pushed over as far as possible in the opposite direction. Assemble first on the left side and then on the right.
5. Lower the power unit so far that the oil pan rests against the lower cross member. Transfer the left retaining iron of the lifting device to the upper screw for attachment of the gearbox on the left side. (This facilitates the next operation, as it gives a more suitable distribution of the weight.)
6. Lift the unit again and fit the transmission pin into the rear engine bracket and the gear rod into the hole in the dash panel.
This operation will be easier to carry out if an assistant guides the transmission pin in through the rear engine bracket with the aid of a suitable arbor. If necessary, also back off the four retaining screws for the steering gear so as to get more room.
7. Fit the limiting washer and center screw in the rear engine bracket. Refit the insulating washer.

NOTE

Check that the limiting washer on the rear of the engine bracket is in position and that it is turned in the right direction, see Fig. This washer serves to limit the forward movement of the power unit. If the washer is missing, there is a risk that the cooling fan will collide with the radiator if the brakes are applied powerfully.

- control to the gearbox.
13. Refit the throttle control.
 14. Fit the exhaust pipes together in the two joints. Do not push the upper pipes on so far that they rest against the floor in the bushings. Reconnect the exhaust pipes to the cylinder heads. Fit new gaskets.
 15. Refit the alternator, cooling fan and fan belt if these items have been removed.
 16. Reconnect all hose and cable connections to the engine.
 17. Refit the radiator and reconnect all coolant hoses. Start with the lower hose.
 18. Fill the radiator with cooling water and ventilate the system through the venting nipples on the thermostat housing and heat exchanger. Check the cooling system for leaks by carrying out a pressure test.
 19. Check the oil level in the engine and top up if necessary.
 20. Reconnect the earth cable to the battery.
 21. Test-start the engine. Note the oil pressure and coolant temperature. Check the coolant level after running up the engine to the warm condition.
 22. Refit the rubber boot on the gear shift rod. Check that the dash panel is positioned in the groove on the boot. Refit the gear shift rod joint.
 23. Refit the pedal plate and the transmission casing. Put the wallboard panels and the floor mat in place.
 24. Refit the hood. See Group 8.
 25. Lower the car onto the wheels. Check the oil level in the gearbox and top up if necessary.
 26. Take the car out for a test run.

DIVISION OF REMOVED POWER UNIT

Disassembly

1. Remove the flywheel guard plate from under the clutch housing.
2. Back off the screws between the engine and the transmission.
3. Remove the starter.
4. Separate the engine from the gear box.

Reassembly

1. Reinstall the gear box, checking that the guide sleeves take up the correct positions in the clutch housing.
2. Tighten the screw for the clutch housing uniformly and with the correct torque.
3. Refit the guard plate for the flywheel and the starter motor.

CONTENTS

500	Description
	Brake shoes with drums, discs and linings
511	Brake shoes*)
512	Replacement of brake linings*)
515	Brake drums*)
516	Brake discs*)
517	Friction pads*)
	Hydraulic footbrake system
520	Overhaul, brake fluid*)
521	Master cylinder
522	Brake lines*)
523	Wheel cylinders*)
524	Brake operation
	Handbrake system
551	Handbrake operation*)

*)See Service Manual Saab V4.

1. The first part of the document discusses the importance of maintaining accurate records of all transactions. It emphasizes that every entry should be supported by a valid receipt or invoice to ensure transparency and accountability.

2. The second part outlines the procedures for handling discrepancies between the recorded amounts and the actual cash flow. It suggests a systematic approach to identify the source of the error and correct it promptly to avoid any financial misstatements.

3. The third part addresses the need for regular audits to verify the accuracy of the records. It recommends that these audits be conducted by an independent party to provide an objective assessment of the financial data.

4. Finally, the document concludes by stressing the importance of maintaining up-to-date records for legal and tax purposes. It advises that all records should be stored securely and for a sufficient period to meet regulatory requirements.

0
0
0
0

BRAKES

Description

The Saab Sonett III is equipped with a brake system of the two-circuit type. Like the Saab V4, it has disc brakes at the front and drum brakes at the rear. The Sonett III, however, has a different pedal stand and brake fluid reservoir. See also the Service Manual for the Saab V4.

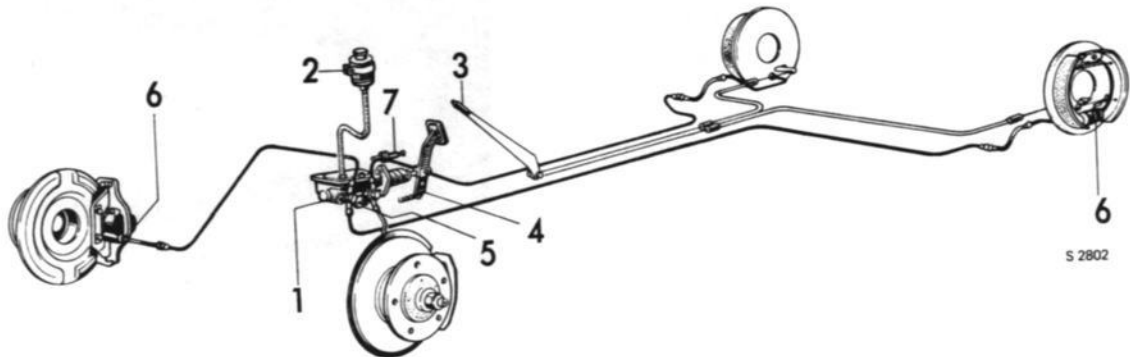

BRAKE SYSTEM

- | | |
|--------------------------|--------------------------|
| 1. Master cylinder | 4. Brake pedal |
| 2. Brake fluid container | 5. Stop light switch |
| 3. Handbrake lever | 6. Brake cylinders |
| | 7. Brake warning contact |

MASTER CYLINDER

General

At intervals not exceeding three years or 35,000 miles (60,000 km), or at each third change of a brake lining, whichever occurs first, renew all rubber cups and seals throughout the hydraulic system. If it is necessary to dismantle the brake system, or any part thereof, this must be done under conditions of scrupulous cleanliness. See also the Service Manual for the Saab V4.

Removal

1. Take out the clutch master cylinder, see Group 4.
2. Disconnect the cables from the stop light switch.
3. Back off and remove the banjo screws for the primary and secondary circuits.
4. Release the filler hose connection to the cap.
5. Back off and remove the retaining bolts for the master brake cylinder and lift the cylinder out.

Installation

Reinstall in reverse sequence.

NOTE:

1. Cover all openings to prevent the entry of foreign matter into the cylinder during the installation work.
2. Adjust the brake-pedal free movement. See Section 524.
3. Bleed the system.

Bleeding the brake system

Bleeding is not a routine service measure and is necessary only when part of the brake system has been disassembled and when the brake fluid has been drained off. Sure signs that air has entered the system are excessive pedal travel, springy pedal action or absence of braking effect until the brake pedal has been firmly depressed several times. A bleed nipple is provided for each wheel. Bleed nipples for the disc brakes are located on the brake cylinder.



LOCATION OF BLEEDING NIPPLES, REAR END

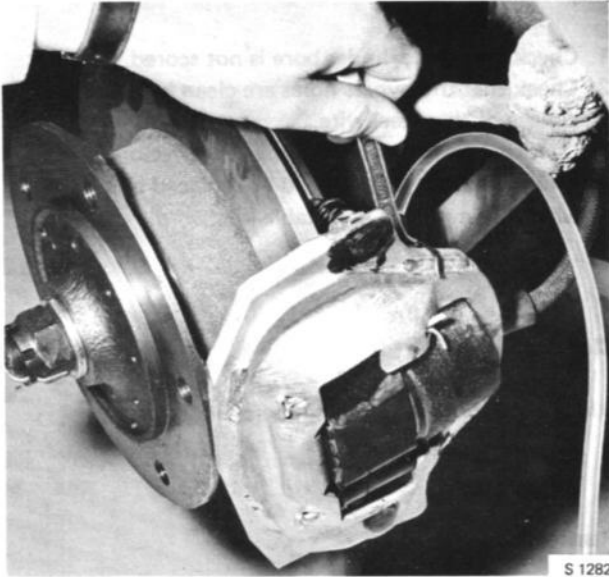

S 1282

LOCATION OF BLEEDING NIPPLE, FRONT END

Bleeding of the brake system is facilitated if the car is jacked up. Proceed as follows:

1. Check that the reservoir is completely full of brake fluid and that the air vents in the reservoir cover are not choked.
2. As the master cylinder has tandem pistons, it will be necessary to bleed the primary circuit first (left front and right rear wheel). It is possible to bleed both wheels at the same time or one wheel at a time. Bleed this circuit completely before starting bleeding the secondary circuit.
Bleed the secondary circuit (right front and left rear wheel.)
3. Fit suitable hoses to the bleed nipples on both wheels.
4. Dip the hose end in a glass vessel containing clean brake fluid.
5. Back off both nipples 1/2–1 turn.
6. Have an assistant pump the brake pedal and watch until escaping brake fluid is free of air bubbles. Keep the hose ends below the fluid level in the glass vessel the whole time.
7. Close the bleed nipples, keeping the pedal depressed meanwhile.

Check that the brake fluid in the reservoir does not run out while the system is being bled.

Top up the reservoir with fresh brake fluid after bleeding the rear and front brakes.

Changing

To change brake fluid, proceed as described in the following:

1. Open the primary circuit bleed nipples (left front and right rear wheel) and connect hoses as when bleeding. Pump the brake pedal until the fluid container is almost empty. Fill new fluid and continue pumping until the entire system is filled with new fluid. Close the bleed nipples.
Repeat the procedure for the secondary circuit (right front and left rear wheel). Pump trough at least half a quart (half a liter). Replenish the container.
2. Bleed the brake system

OVERHAUL OF MASTER CYLINDER

The master cylinder should only be dismantled if there is no exchange system for this unit.

Dismantling

1. Remove the rubber bellows 11 together with retaining plate 8 and the push rod 31.
2. Press down the spring retainer 30 and remove the spiral clip 29 with the aid of a small screwdriver.
3. Remove the outer lock ring 28, the nylon bearing 27, the cup 26, and the washer 25.
4. Remove the inner lock ring 24 with the aid of special tool 784199 and remove the pistons.

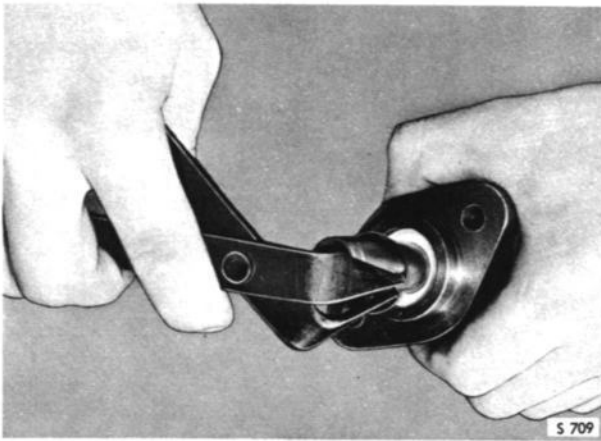

REMOVING THE LOCK RING
Tool 784199

NOTE

Be careful when removing the locking ring and the washer so that the surface of the pistons is not damaged.

5. Compress the intermediate spring 18 together with spring holder 20 and drive out the retaining pin 19, using a suitable pin punch. This will separate the two pistons 10 and 14, and allow the withdrawal of the spring 18 and spring holder 20.
6. Withdraw the non-return valves. Take care not to distort the spring clip 44 when removing it from the valve body.
7. Remove the six bolts retaining the cover of the brake-fluid reservoir 5 and take off the cover together with the gasket.

Inspection

1. Check that the cylinder bore is not scored.
2. Check that the bypass holes are clean by probing with a piece of thin steel wire.
3. Check all parts, and renew any defective ones.
Internal rubber parts should be replaced by new ones, which are available in suitable kits.

Cleaning

Always use spirit for cleaning the cylinder parts.

Reassembly

Before reassembling the master cylinder, dip all parts in brake fluid.

1. Locate the cups on the pistons and check that they are correctly positioned, see fig.

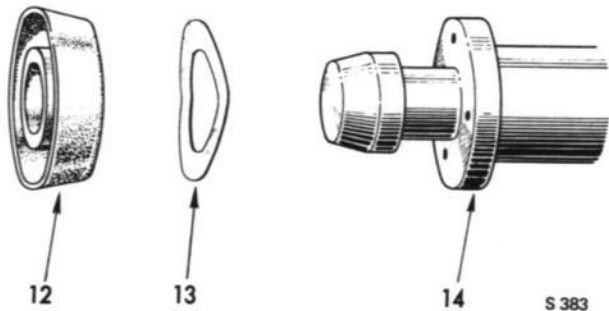

FITTING THE PISTON WASHER

12. Primary cup
13. Piston washer (dished)
14. Secondary piston

2. Install the spring 18 on the pistons and press them together so that the retaining pin 19 can be installed.
3. Fit the pistons in the cylinder. Note! Be careful so that the gaskets are not damaged.
4. Install the piston stop 23.
5. Mount spiral clip 24 with the aid of tool 784199.
6. Install the washer 25, the secondary cup 26 and the nylon bearing 27. Lock with spiral clip 28.
7. Install spring 9 and spring retainer 30 on the primary piston 10.
8. Compress the retain spring 10 and install the spiral clip 29.
9. Lubricate the small end of the push-rod 31 with silicon grease and install the rubber bellows 11 with retainer 8.
10. Screw on the outlet adapters and non return valves. Tighten to 38 Nm (28 ft.lb., 3.8 kpm).
11. Install the cover 5 and tighten the screws to 7 Nm (6 ft.lb., 0.7 kpm).

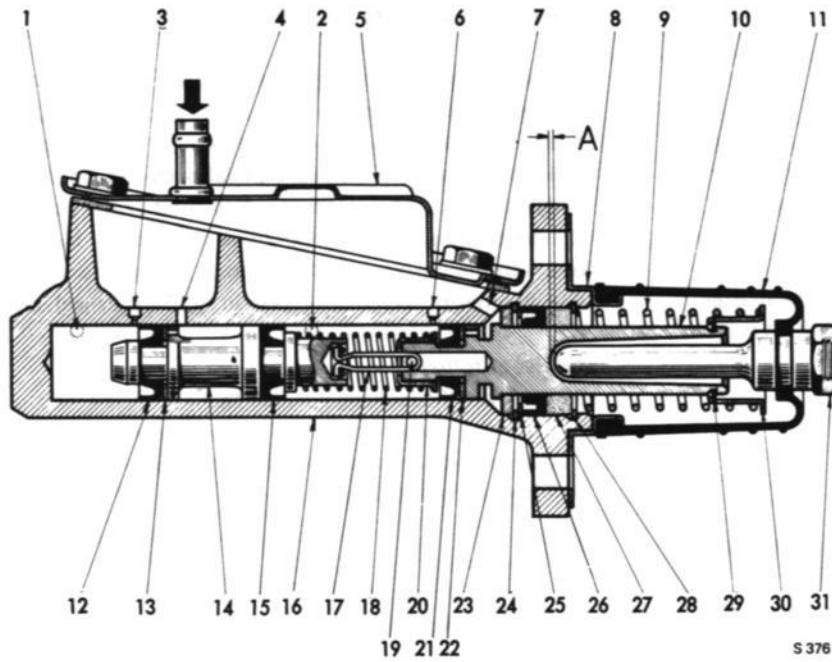

MASTER CYLINDER

1. Outlet to the secondary circuit
 2. Outlet to the primary circuit
 3. By-pass port
 4. Feed hole
 5. Lid
 6. By-pass port
 7. Feed hole
 8. Retaining plate
 9. Spring
 10. Primary piston
 11. Rubber bellows
 12. Primary cup
 13. Piston washer
 14. Secondary piston
 15. Secondary cup
 16. Body housing
 17. Clip
 18. Spring
 19. Retaining pin
 20. Spring holder
 21. Primary cup
 22. Piston washer
 23. Piston stop ring
 24. Lock ring
 25. Washer
 26. Secondary cup
 27. Nylon bearing
 28. Lock ring
 29. "Spirolox" circlip
 30. Spring retainer
 31. Push-rod
- A = 0,023—0,047 in.
(0,6—1,2 mm)

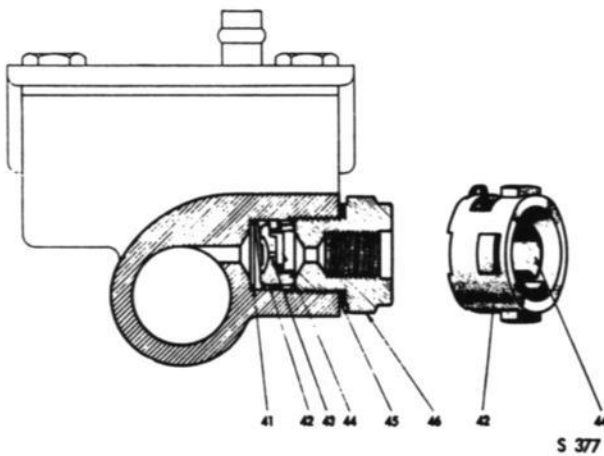
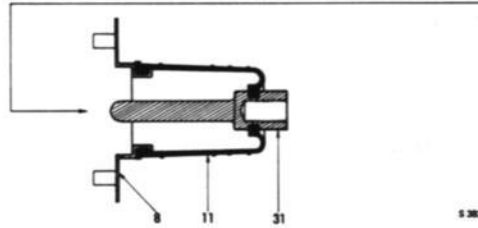
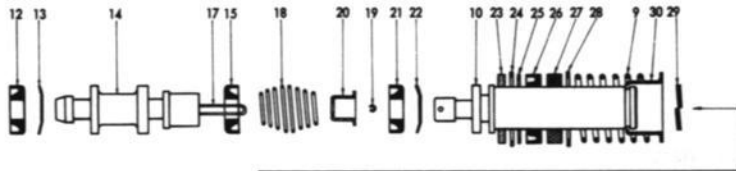

NON-RETURN VALVE IN MASTER CYLINDER

41. Return valve spring
42. Valve body
43. Equalizing hole
44. Outlet valve spring clip
45. Gasket
46. Adapter

BRAKE OPERATION

Brake pedal

The brake pedal is carried together with the clutch pedal under the pedal plate on a common shaft. The shaft, in its turn, is carried in two brackets which are welded to the dash panel and floor. The master cylinder is attached to the dash panel.

The brake-pedal movement is transmitted to the master cylinder via a push-rod of adjustable length which is pivot-connected to the pedal.

Pedal stand

Each pedal can be removed separately if the pedal shaft is removed.

1. Remove the floor mat and the wallboard panels. Remove the gear lever knob and rubber boot. Remove the gearbox cover (4 screws).
2. Back off and remove the screws holding the pedal plate and lift out the two parts of the latter.
3. Release the clutch-pedal push-rod by removing the cotter pin and shaft bolt.
4. Release the return springs of the brake pedal and clutch pedal.
5. Strike out all slotted pins and pull out the pedal shaft.
6. Detach the push-rod from the rubber boot, thereby enabling the brake pedal to be separated from the master cylinder. When the pedal is then lifted out, it will be accompanied by the push-rod.

Reinstall in the reverse sequence and then adjust the brake-pedal free movement.

Adjustment of brake-pedal free movement

In order to ensure that the piston in the master cylinder will return fully every time the brake pedal is released, there must always be a clearance between the master-cylinder piston and the brake-pedal push-rod when the pedal is at rest. This clearance, measured at the tip of the pedal, should be 0.12–0.24 in. (3–6 mm). Measured between the push-rod and the piston, the clearance should amount to 0.024–0.047 in. (0.6–1.2 mm). See fig.

Adjust as follows:

1. Back off the locking nut, see fig.
2. Turn the hexagonal part of the push-rod until the correct clearance is obtained at the tip of the pedal.
3. Tighten the locking nut.

Brake warning system

See Group 3 "Electrical controls and switches".



BRAKE PEDAL FREE MOVEMENT

A = 0.12–0.24 in. (3–6 mm)

CONTENTS

- 600 Description
- 601 Wheel alignment
 - Front assembly
- 631 Steering knuckle housing and ball joints*
- 632 Control arms*
 - Steering column shift gear
- 641 Steering wheel, steering column and steering wheel lock
- 642 Steering gear*
- 643 Tie-rod ends*

*) See Service Manual Saab V4.

○

○

○

○

DESCRIPTION

The front assembly and steering mechanism are of exactly the same design as those installed in the Saab V4. The Sonett III, however, features a steering wheel lock and a leather-covered sports-type steering wheel. See also the Service Manual for the Saab V4.

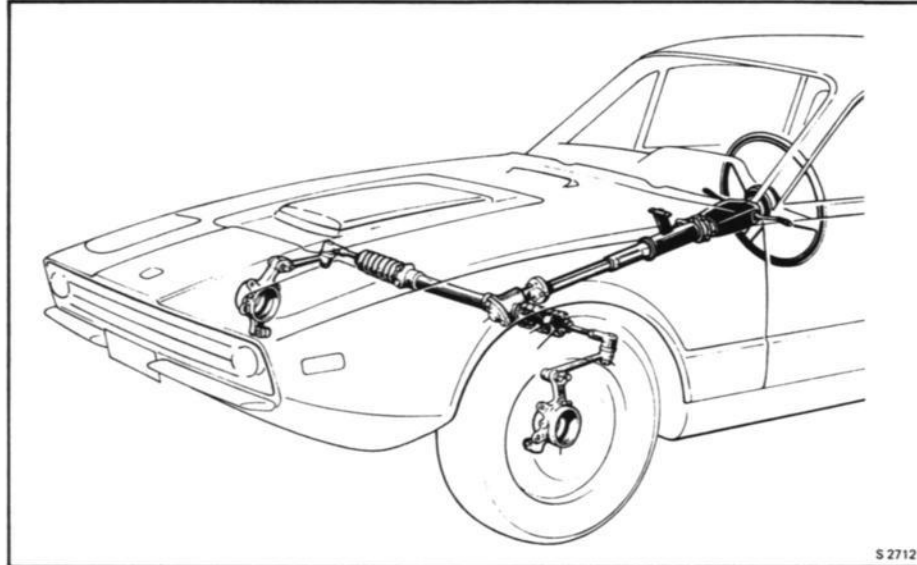

STEERING MECHANISM

WHEEL ALIGNMENT

General

It is of the utmost importance that the front wheels be correctly aligned, since incorrect steering geometry can cause:

1. Driving fatigue, due to impaired roadability.
2. Increased tire and repair costs due to abnormal wear of tires and steering mechanism.

If there is reason to suspect incorrect front-wheel alignment as the result of an accident or of driving into the ditch, for example, or if road behaviour otherwise is noticeably impaired, the car should immediately be taken to an authorized service shop for inspection and adjustment. Even if there is no direct reason to suspect faulty wheel alignment, the car should nevertheless be checked at regular intervals and adjusted whenever necessary.

The angles and dimensions directly affecting the front-wheel alignment, all of which are closely interrelated, are the following:

King-pin inclination

Caster

Camber

Toe-in and

Wheel turning angles

1. Check that the tire pressure is correct and that the front tires are not too unevenly worn.
2. Check the front wheel bearings, control arm bearings, ball joints and tie-rod ends, adjusting or replacing as necessary in order to eliminate errors that can be caused by worn parts.
3. Check the steering gear and adjust any faults — see Service Manual Saab V4.
4. Check the function of the shock absorbers and renew any defective shock absorbers and rubber bushings.
5. If the car has been involved in an accident, driven into the ditch, etc., any damage incurred must be repaired before the alignment check. Distorted steering arms must be rejected and new ones fitted, as restraightening is not permitted.
6. Immediately prior to the check, drive the car with normal suspension movement but without hard cornering in order to avoid deceptive misalignment. For the same reason, the car should also be rocked a few times.

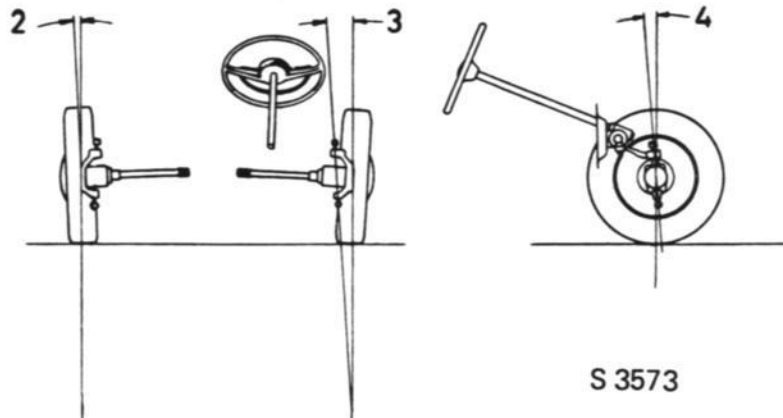
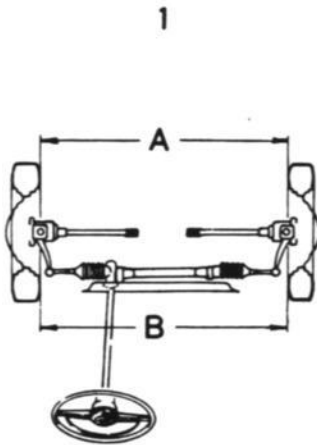

FRONT-WHEEL ALIGNMENT

1. Toe-in
2. Camber
3. King-pin inclination
4. Caster

During the alignment check, the car must be unladen and standing on a flat, horizontal floor, as otherwise measurements will not be reliable.

All adjustment with shims must be kept within reasonable limits. Deformation resulting from crash damage, etc., must be corrected by thorough realignment of the chassis. Distorted control arms must be rejected and new ones fitted.

For checking wheel alignment there are various standard tools, which are fitted either to the rim or directly on the stub axle. Tool handling is described in the instructions for each individual tool.

NOTE

When using axle-fitted tools on cars with a front-wheel drive, the wheels must stand on turn-tables or similar devices and should be locked with the brakes during the course of the check.

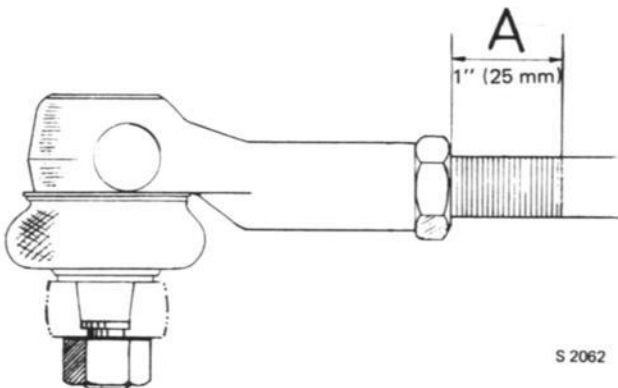

MAX. PERMISSIBLE DISTANCE BETWEEN LOCK NUT AND THREAD RUN-OUT

FRONT-WHEEL ALIGNMENT

Toe-in

Viewed from above, the wheels should have a certain relationship to each other, expressed as the difference between dimensions A and B, measured rim-to-rim at axle height. See fig.

The setting is called toe-in when dimension A is less than dimension B. When A is greater than B, the wheel setting is referred to as toe-out.

Toe-in or toe-out is expressed in inches or millimeters, being — as stated — the difference between the two measurements A and B. If the wheels are parallel, so that there is neither toe-in nor toe-out, the difference will be 0.

The correct setting is 0.04 ± 0.04 in. (1 ± 1 mm) toe-in, i.e. $B - A = 0.04 \pm 0.04$ in. (1 ± 1 mm) ± 0.04 in. (1 mm). Dimension A should be 0.0–0.08 in. (0–2 mm). less than dimension B.

Checking and adjustment

1. Roll the car slowly straight ahead on a level floor and stop it without using the brakes. Do not move the car backwards again.
2. Check the measure A using the special measuring rule, between the edges of the rims at axle height. Make a scribed mark at the measure points. Move the car forward until the scribed mark comes in axle height again. Check measure B.
If adjustment is called for, alter the length of the tie-rods.
3. Back off the locknut on the outer end of the tie-rod.
4. Turn the tie-rod with the aid of a pair of pliers to right or left, and search until obtaining the right toe-in, see table.

NOTE

If the rubber boot is so tightly clamped that it accompanies the tie-rod when turned, the clamping ring must first be slackened a little.

If the toe-in is correct, and when both wheels are pointing straight ahead, the two tie-rods should be of equal length, or else be so set that the wheels have the same amount of clearance from fenders and wheel houses when turned hard right or hard left. Check also that the spokes of the steering wheel are horizontal when the wheels are centered. Remember to tighten the tie-rod locknuts after adjustment.

NOTE

After adjustment of toe-in, the measurement A must on no account exceed 1.0 in. (25 mm). .
For tie-rods opposed to each other, the difference between the measurements "A" must not exceed 0.08 in. (2 mm).

Reading, value of toe-in		Screw tie-rod in or out, the following 1/4 turns
Toe-out mm and in.	6 0.24 in.	7 out
	5 0.19 in.	6 out
	4 0.16 in.	5 out
	3 0.12 in.	4 out
	2 0.08 in.	3 out
	1 0.04 in.	2 out
	0	1 out
Toe-in mm and in.	1 0.04 in.	Correct value
	2 0.08 in.	1 in
	3 0.12 in.	2 in
	4 0.16 in.	3 in
	5 0.19 in.	4 in
	6 0.24 in.	5 in
	7 0.28 in.	6 in
	8 0.31 in.	7 in
	9 0.35 in.	8 in
	10 0.39 in.	9 in

TOE-IN/TOE-OUT ADJUSTMENT TABLE

CAMBER

Camber is understood to mean the deviation of the wheel from the vertical, see fig. If the wheel tilts outwards, camber is positive (+), and if it tilts inwards, camber is said to be negative (-).

The correct camber for the Sonett III is $0^{\circ} \pm 1/4^{\circ}$ in other words, the wheel must be vertical.

Checking and adjustment

Camber, and thus king-pin inclination also, can be adjusted by inserting shims under the bearing brackets of the upper control arms. The desired result can thus be obtained by the addition or removal of shims.

Increasing the thickness of shims under both brackets by 0.1 in. (2.5 mm) reduces camber by approx. $1/2^{\circ}$.

If, on the other hand, an 0.1 in. (2.5 mm) shim is removed from under each bracket, camber will be increased by approx. $1/2^{\circ}$.

Shims of equal thickness must always be used under both brackets.

CASTER

Caster is the deviation of the king-pin axis from the vertical when viewed from the side, and is generally expressed in degrees. Caster varies greatly from car to car. In most cases, the king-pin is inclined rearwards, as illustrated, and caster is then said to be positive (+). If the king-pin is inclined forwards, caster is said to be negative (-). Finally, the king-pin may be perfectly vertical, in which case caster is 0. In the Sonett III, caster should be $2 \pm 1/2^{\circ}$ positive.

Checking and adjustment

If caster adjustment is called for, this can be done by inserting shims under the bearing brackets of the upper control arms.

Transference of shims with a thickness of 0.02 in. (0.5 mm) from under the front bracket to under the rear bracket results in a $1/2^{\circ}$ increase in caster.

Transference of shims with a thickness of 0.02 in. (0.5 mm) from under the rear bracket to under the front bracket results in a $1/2^{\circ}$ decrease in caster.

The same thickness of shims as is removed from under one bracket must thus always be fitted under the other bracket.

KING-PIN INCLINATION

In point of fact, there is no king-pin in the true sense of the term in the Saab car, and the term king-pin inclination is therefore instead applied to the inclination of the imaginary axis which passes through the centers of the two ball joints and meets the ground near the center line of the wheel. The correct inclination is $7 \pm 1^{\circ}$.

Checking and adjustment

King-pin inclination is adjusted at the same time as camber and is changed by the same angle. It is not possible to adjust king-pin inclination alone, as this is determined by the steering knuckle. If the king-pin inclination is incorrect after adjustment of camber, the fault is to be found in the steering knuckle which should be renewed.

WHEEL TURNING ANGLES

If wheel alignment is correct, all four wheels will describe circles with a common center when the car takes a curve, and as the rear wheels are fixed this center must lie somewhere on their extended axis. As shown in the figure below, the inner front wheel must be turned more than the outer one when taking a curve, in order for both wheels to move around the same center.

Correct steering geometry depends essentially on the alignment of the steering arms, but the tie-rod alignment also has some bearing on it, particularly when suspension movement occurs, see fig.

Checking and adjustment

Before checking of turning angles is commenced, the toe-in must be correctly adjusted. To measure the turning angles, use is made of two standard-type turn-tables with arc graduations or optical measuring equipment – see fig. Position the turn-tables as close to the wheel turning center as possible.

Turn the steering wheel to, for instance, the left, until the graduated disc for the front wheel shows a reading of 20° . If the turning setting is correct, the other disc should give a reading of $22\frac{1}{2}^{\circ} \pm 1\frac{1}{2}^{\circ}$.

Measure in the corresponding manner when the steering wheel is turned in the opposite direction. If measurement reveals that the turning angles are incorrect, one or both steering arms is deformed. Defective steering arms must not be restraightened but must be changed instead.

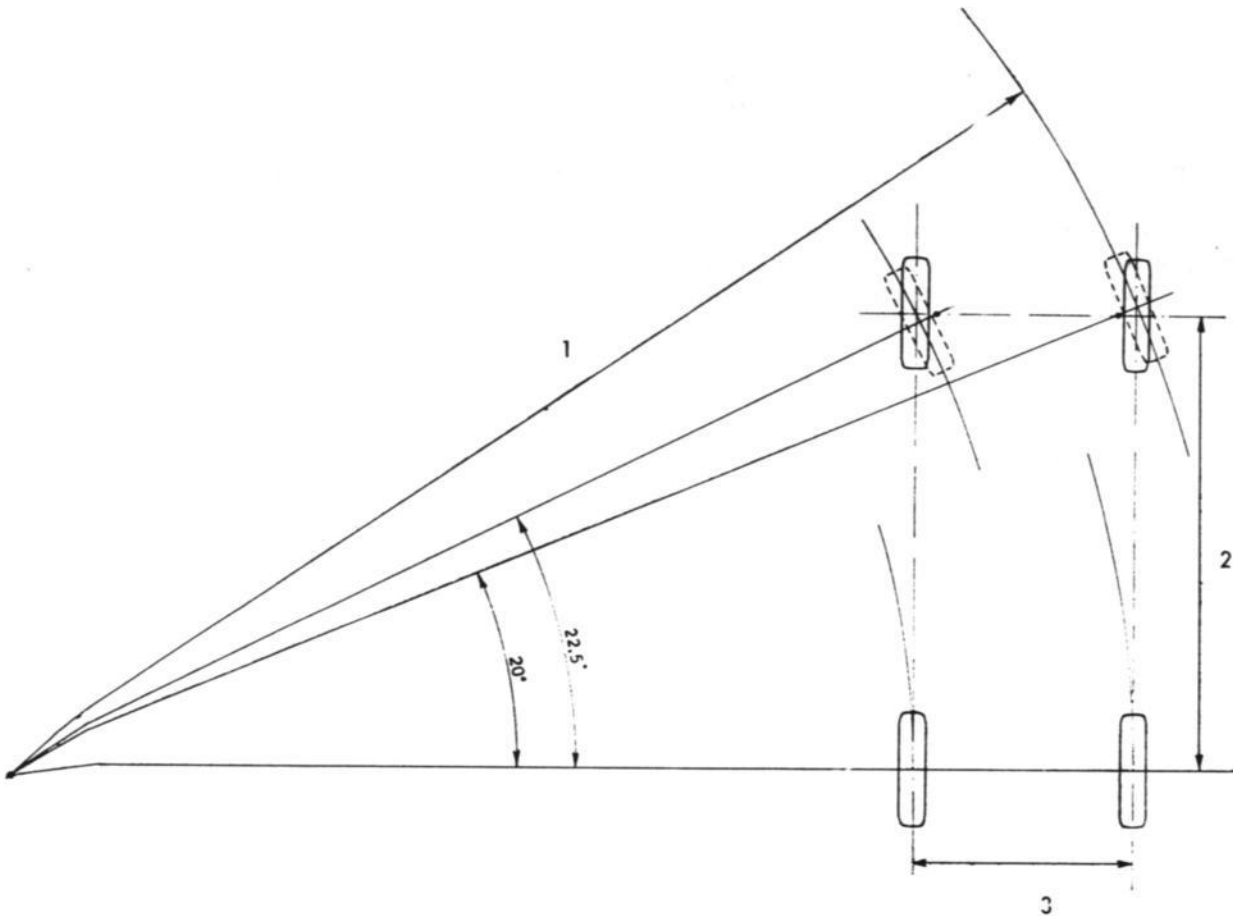

TURNING ANGLES OF FRONT WHEELS

1. Turning radius
2. Wheel base
3. Track

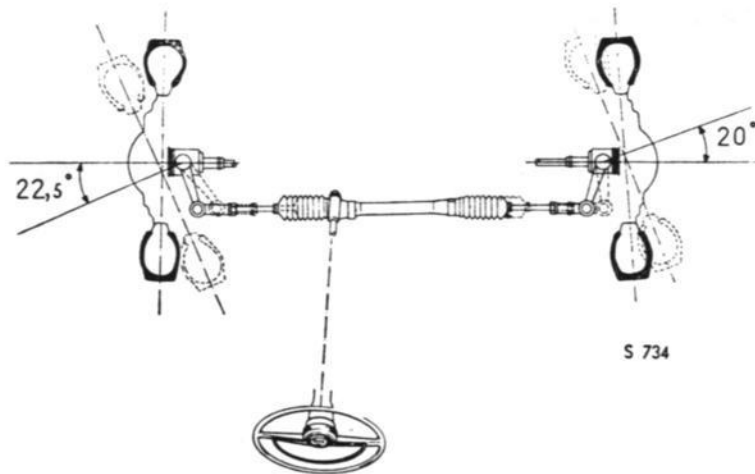

WHEEL TURNING ANGLES

REAR-WHEEL ALIGNMENT

Checking

If the rear axle has been subjected to abnormal stresses, for instance in connection with a collision or other accident, it must be carefully checked for signs of fracture or deformation.

Normally, rear-wheel alignment does not require adjustment. If, however, the rear axle has been subjected to such abnormal stresses that faulty alignment of the rear wheels is suspected, the wheel angles should be checked. If the wheels are correctly aligned, the angles should be within the following limits:

Camber	$0 \pm 1^{\circ}$
Toe-in (toe-out) must not exceed:	
per wheel	$0 \pm 3/4^{\circ}$
both wheels together	$0 \pm 1^{\circ}$
both wheels together measured rim-to-rim	0 ± 0.28 in. (7 mm)
Max. difference in wheelbase, left and right (front wheels pointing straight ahead):	0.6 in. (15 mm)

On condition that the wheel angles are within the values stipulated above, the difference in wheelbase between the left and right sides may amount to a maximum of 0.6 in. (15 mm).

NOTE

Special wheel-angle measuring equipment is needed to establish faults in toe-in (toe-out).

NOTE

If the difference in wheelbase exceed 0.2 in. (5 mm), the wheel alignment must be checked. Wheel alignment can be incorrect without this affecting the wheelbase.

STEERING WHEEL, STEERING COLUMN AND STEERING WHEEL LOCK

Removal of steering wheel

1. As from model 1971: Pry off the signal contact with the fingers. Disconnect and cut off the cable terminal.
2. Remove the safety pad by turning it counter-clockwise.
3. Unscrew the nut and remove the spring washer and the spacer.
4. Lift away the steering wheel.
5. The washer under the steering wheel and the return yoke for the direction indicator switch can now be removed.

WARNING

The collapsible steering wheel shaft must be handled with care. It must not be subjected to impacts, jolts or other rough treatment liable to alter the adjusted length of the telescope joint or impair its shock-absorbing effect.

When installing the steering wheel shaft, take special care to ensure that the splined lower end is pushed into the intermediate shaft until the clamping screw comes opposite the groove in the shaft. The intermediate shaft should normally slide freely on the shaft. If the splines stick, do not on any account knock on the top end of the steering wheel shaft. This also applies to removing and fitting the steering wheel. The wheel must not be knocked off or on.

Reassembly

1. Refit the return yoke if previously removed.
2. Check the clearance between the return yoke and the projection on the switch. The correct clearance is 0.008–0.024 in. (0.2–0.6 mm) with the switch at neutral. Adjust the clearance by inserting shims between the switch and the column stand. Fit the return yoke so that its center line coincides with that of the switch housing when the wheels are aligned straight ahead.

CAUTION

Make sure that the return yoke is not fitted so far forward that it can damage the switch for the windshield wipers. (Valid for model 1970 only).

3. Fit the steering wheel on the shaft. While this is being done, the front wheels must be aligned straight ahead and the steering wheel pushed onto the center pin of the shaft so that two of the steering wheel spokes are horizontally positioned and the third one points downwards. Check that there is a clearance between the steering wheel and the covers. If necessary, adjust with spacers.
4. Refit the spacer, the spring washer and the nut.
5. Model 1970:
Refit the safety pad by screwing it in clockwise as far as it goes.

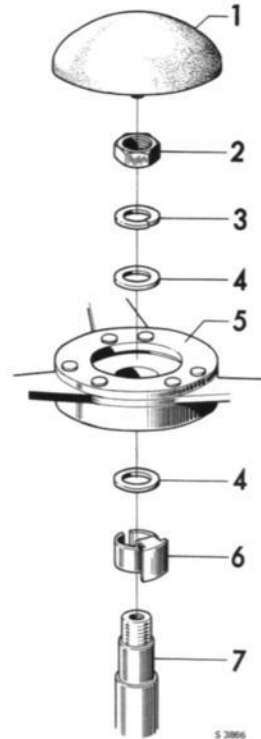

STEERING WHEEL AND SAFETY PAD MODEL 1970

1. Safety pad
2. Nut
3. Spring washer
4. Spacer
5. Steering wheel
6. Return yoke
7. Steering wheel shaft

As from model 1971:

Pull the cable for the signal through the earth cable clip of the signal contact and the center hole of the safety pad. Fit a new cable terminal. Refit the safety pad, connect the cable to the signal contact and press the signal contact into the safety pad.

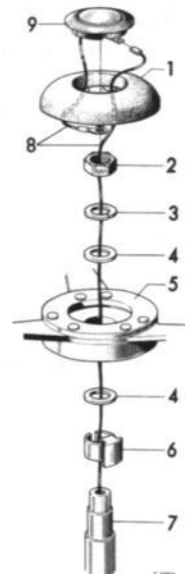

STEERING WHEEL AND SAFETY PAD AS FROM MODEL 1971

1. Safety pad
2. Nut
3. Spring washer
4. Spacer
5. Steering wheel
6. Return yoke
7. Steering wheel shaft
8. Cables
9. Signal contact

Steering column and bearings

Disassembly

1. Disconnect the battery cable.
2. As from model 1971:
Pry off the signal contact with the fingers and disconnect the cable from the knob. Cut off the cable which is wound round the lower part of the steering shaft about 6" below the rubber grommet in the steering shaft.
Remove the rubber grommet for the cable from the steering wheel shaft, unscrew the safety pad and remove it together with the signal contact and the upper part of the cable.
3. Unscrew the clamping screw at the joint on the lower part of the steering wheel shaft.
4. Remove the covers of the steering column and take the flasher- and windshield wiper switches away. Remove the tape that keeps the cables to the steering wheel column.
5. Remove the ignition- and starter contact by undoing the two screws which can be reached from the side of the steering wheel lock.
6. Remove the buzzer contact. The contact is placed to the right on the upper side of the steering wheel lock and can be loosened with the fingers or if necessary with a pair of polygrip pliers.
7. Disconnect the instrument insert from the instrument panel (pass the speedometer cable in from the engine compartment), thus providing access to the two retaining screws for the column stand and enabling these to be removed. Note the washer under the two screws.



COLUMN STAND RETAINING SCREWS

8. As from model 1971:
Remove the strip which keeps the steering column to the cross support. It is necessary to remove only the left hand side screw and nut. Fold back the strip (3/8" nut).
9. Pull the steering wheel shaft out of the steering gear pinion. The steering column is now loose and can be removed from the car.
10. Clamp the lower part of the steering wheel shaft

in a vice and remove the steering wheel. Remove the actuator with a screw driver.

11. Make sure that the steering wheel lock is free and pull the steering column stand upwards. It might be necessary to pry off the lower rubber bushing with a screwdriver to loosen the steering column.

Reassembly

1. Check that the steering wheel shaft bushings are correctly mounted in the grooves of the rubber bushings. Mount the upper bushing in the steering column. (The arrow should point towards the steering wheel.)
2. Push the steering wheel shaft into the steering column and mount the lower bushing in the column. Lock the steering wheel lock and check that the lock plunger enters the twist stop.
3. As from model 1971:
Prepare the mounting of the signal cable by putting a steel wire in the steering shaft.
4. Refit the column in the car and connect the steering shaft to the steering gear pinion. (The front wheels should be aligned straight ahead.) Attach the steering column with the two screws. Do not forget the washer under the two screws.
5. Adjust the spline connection at the steering shaft joint and fit and tighten the clamping screw. (As from model 1971 the earth cable must be connected to the clamping screw.)
6. Check that there is a clearance between the steering column and the flange of the steering shaft. Tighten the two screws for the steering column. As from model 1971: refit also the strip around the steering column.
7. Refit the instrument insert (pull the speedometer cable back into the engine compartment).
8. Refit the flasher and windshield wiper switches and fix the cables to the steering column with tape.
9. Refit the ignition- and starter contact and the buzzer contact.
10. Refit the actuator so that its center line coincides with that of the switch housing when the wheels are aligned straight ahead. The actuator should be fitted so that it is situated about 1 mm below the tooth of the switch.

WARNING

Make sure that the actuator is not fitted so far down that it can damage the switch for the windshield wipers (model 1970).

11. Refit the covers for the steering column and fit the steering wheel. Refit the washers so there is a clearance between the steering wheel and the covers.
12. As from model 1971:
Pull the cable for the signal contact through the center hole of the safety pad and the earth cable clip of the signal contact. Then pull cable through

- the steering wheel shaft using the steel wire earlier prepared. Refit the safety pad, connect the cable to the signal contact and press the signal contact into the safety pad. Fit the rubber grommet, wind the cable 3—4 turns around the steering wheel shaft and connect the cables with a joint sleeve.
- 13. Reconnect the battery cable.

WARNING

The collapsible steering wheel shaft must be handled with care. It must not be subjected to impacts, jolts or other rough treatment liable to alter the adjusted length of the telescope joint or impair its shock-absorbing effect.

When installing the steering wheel shaft, take special care to ensure that the splined lower end is pushed into the intermediate shaft until the clamping screw comes opposite the groove in the shaft. The intermediate shaft should normally slide freely on the shaft. If the splines stick, do not on any account knock on the top end of the steering wheel shaft.

This also applies to removing and fitting the steering wheel. The wheel must not be knocked off or on.

Replacement of steering wheel lock

1. Remove the steering wheel shaft — see this section.
2. Drill out the two retaining screws for the steering wheel lock, using a drill bit with a diameter of approx. 5/16" (8.0 mm). It is advisable to do this against the threaded part of the screws, since the screw holes serve as guides for the drill.
3. Fit a new lock, tighten the screws but do not break the screw heads.
4. Refit the steering wheel shaft — see this section.
5. Check the functions of the steering wheel lock and ignition lock. Having done this, break the screw heads.

STEERING WHEEL LOCK

General

The ignition switch and steering wheel lock has four positions:

- O. Locked. The key can only be withdrawn from this position. When the key is withdrawn the steering wheel is locked.

Note! To ensure that the car isn't left unlocked, there will be a buzzer activated if the door is opened with the key left in the ignition lock.

- I. All current consumers except the ignition circuit is switched on.
- II. Drive. All electric systems are operational.
- III. Start. This position has a spring-loaded action to II.

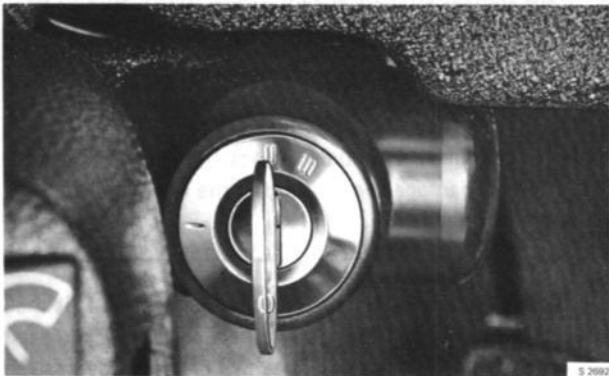

STEERING WHEEL LOCK

CONTENTS

700	Description
	Suspension
731	Coil-spring suspension, front*
732	Coil-spring suspension, rear*
	Shock absorbers, stabilizer
761	Shock absorbers
	Wheels and hubs
771	Wheels*
772	Tires*
774	Hubs*

*) See Service Manual Saab V4.

0

0

0

0

SUSPENSION, WHEELS

Description

Front suspension

The Sonett III is provided with the same suspension system as the Saab V4, except that different coil springs are used. See also the Service Manual for Saab V4.

Rear suspension

The coil springs are made especially for the Sonett III. See also the Service Manual for Saab V4.

Shock absorbers

The shock absorbers are made specially for the Sonett III. See also the Service Manual for Saab V4.

Wheels and hubs

See the Service Manual for Saab V4.

Rims and tires

The Sonett III is equipped with "wide base" disc wheels, 4 1/2" J x 15" or 4 1/2" FJHA x 15" with 5 wheel screws and 155 SR 15 radial tires.

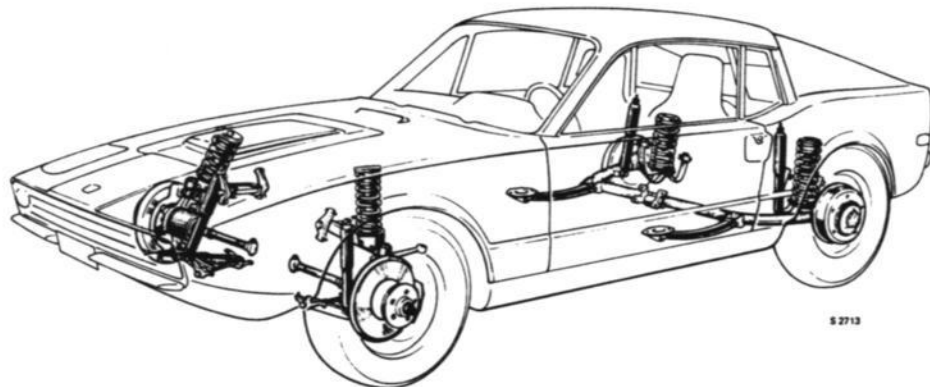

SUSPENSION

○

○

○

○

CONTENTS

800	Description
810	Body assembly
820	Hood and engine lid
830	Doors
843	Glass
850	Upholstery and interior fitment
860	Bumpers and grille
890	Body finishing

0

0

0

0

BODY

Description

The body comprises a body shell which is bolted and riveted to a supporting chassis frame.

The shell is made of fiberglass-reinforced plastic and consists of only five parts. The roof section comprises not only the actual roof but also the rear section with the rear fenders. Reinforcements are provided in the windshield pillars in the form of embedded steel sections. The hood and front fenders form a single unit. A hinged engine lid, through which normal service inspections can be carried out, is mounted on the hood. The doors consist of a steel frame to which the plastic shell is riveted. The rear window, which is made of toughened glass, also serves as the luggage compartment lid.

The chassis frame is of pressed steel and consists of a flat floor, side beams, front and rear wheel houses, dash panel and a partition wall behind the seats. The floor is flat and at the sides rigidity is provided by the box-shaped sills. A roll bar of tubular steel is located between the roof and the partition wall. The luggage compartment comprises the rear part of the car. The compartment floor consists of a sheet of plywood under which the spare wheel and the battery are carried in a special compartment.

Body insulation and fitments

A layer of insulation compound has been sprayed onto the outside of the wheel houses, affording protection against flying stones and corrosion besides having a certain sound-absorbing effect.

The floor is internally insulated with waffle-pattern paper-board and sheets of wallboard under the front floor mat and covered with carpeting both in the passenger compartment and in the luggage compartment. The lining is glued to the body in the roof as well as on the wheel houses, sills, seat rails and partition compartment. The door lining is fitted on with clips and the luggage-compartment lining is secured with screws.

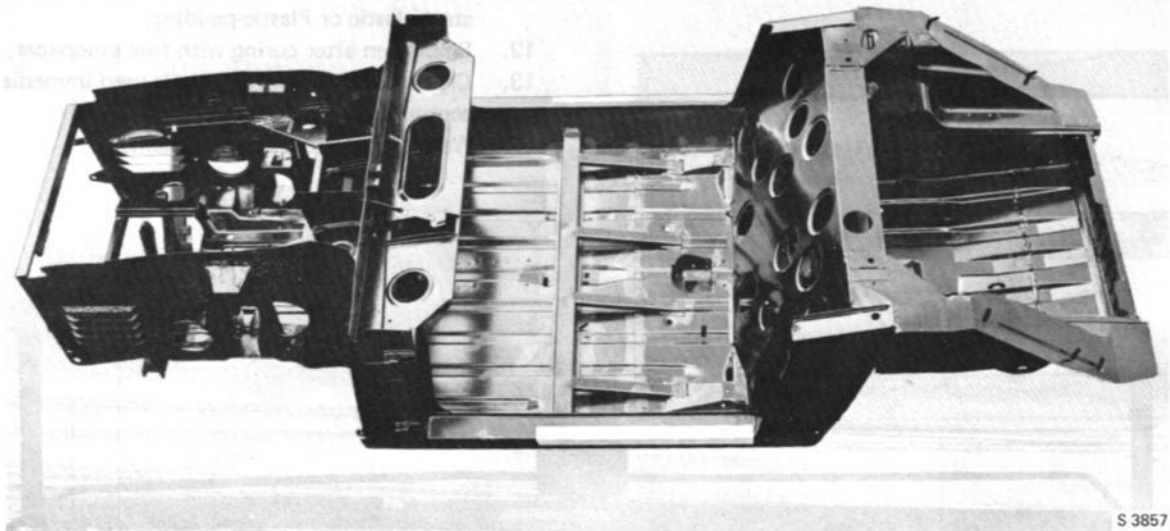

S 3857

BODY FRAME

BODY ASSEMBLY

Chassis and body

The body frame can be repaired in accordance with the directions given in the Service Manual for the SAAB V4. The special tools recommended there can also be used, except for the aligning tool No. 784007 which is unsuitable on account of the shorter wheelbase on the Sonett III.

Body shell

General

The body shell can be repaired either by replacement of complete parts or by mending the damaged piece, depending on the extent of the damage. When mending local damage, the damaged piece should be ground away. It is best if both sides can be ground as per alternative A, but if this proves difficult it will suffice to grind one side only as per alternative B. In an emergency, damage can be mended as indicated in Fig. C, where a reinforcement consisting of fiberglass matting and plastic has been applied to the rear side. Small holes or pores can be drilled out and then filled with plastic putty. See Fig. D. Large holes right through the body shell can be repaired by securing a mould of rubber, etc., to which release agent has been applied to the outside of the panel and then applying plastic and fiberglass cloth to the inside.

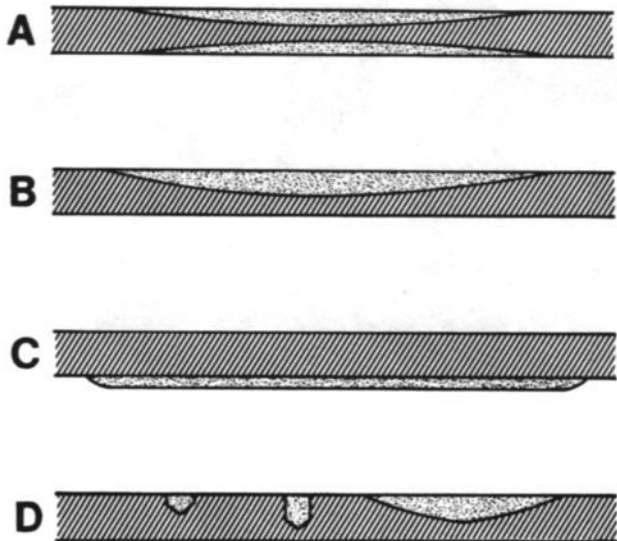

TYPICAL BODY SHELL REPAIRS

S 1212

Body shell repair procedure

Materials:

Fiberglass matting (type 300 g)

1" brush

Sandpaper (coarse)

Sandpaper (fine)

Acetone

Trichloroethylene

Plastic of good quality, e.g. Soredur H43 containing an accelerator.

Catalyser

Plastic-padding

1. Apply masking tape around the damaged area (to avoid scratches on undamaged parts).
2. Scrape off all loose particles from the damaged area with a knife.
3. Roughen up the surface with coarse sandpaper.
4. Degrease the damaged surface with trichloroethylene.
5. Make sure that the surfaces are properly aligned.
6. Cut out a suitably sized piece of fiberglass matting.
7. Apply catalyser to the plastic. The correct mixing is usable for 15–20 minutes at room temperature.
8. Coat the damaged area with the plastic mixture and then insert the first layer of fiberglass matting. Repeat this procedure until the damaged part has been completely filled out. NOTE! Make sure that the fiberglass matting is thoroughly drenched with plastic and that no air bubbles are built in (stipple).
9. Cure for about an hour at 20°C. Examine. After curing, the surface must be cold and hard.
10. Grind with coarse sandpaper or, in the case of large irregularities, with a file.
11. Fill any pores and cavities with putty, using either steel plastic or Plastic-padding.
12. Smoothen after curing with fine sandpaper.
13. Clean the brush and any tools used immediately in acetone.
14. Water-grind and coat with enamel.

Disassembly of body

1. Disconnect the battery cable from the battery.
2. Remove the hood. See section 820.
3. Remove the side and rear linings in the luggage compartment. Remove the opening side windows, remove the weather strip and unfasten the side linings.
4. Lift out the insulation sheets at the rear. Remove the rear-window lock. Remove the stay (2 screws towards the body and 1 screw in the lower edge).

NOTE

Mark out the position of the lower screw in the rectangular hole in the stay.

5. Bend up the locking tab and open up the cable-harness jointing sleeve on the rear left wheel house. Detach the two earth cables from the floor panel.
6. Back off and remove the nuts at the rear edge of the rear wheel houses above the silencers, one on each side.



REMOVAL OF NUTS ABOVE THE REAR SILENCER

7. Remove the steel strip holding the body to the body frame underneath at the rear (6 screws).
8. Remove the tank cap and the rubber ring and back off and remove the four screws holding the filler pipe.
As from model 1971: Loosen the vent hose for the fuel tank at the tank and in the engine compartment.
9. Remove the rear window by unscrewing the four screws at the roll-over bar.



REMOVAL OF SCREWS FOR REAR WINDOW

10. Remove the upper part of the weather strip for the apertures of doors.
11. Remove the striker plates for the door locks.
12. a) Drill out the pop rivets on the rear door pillars.

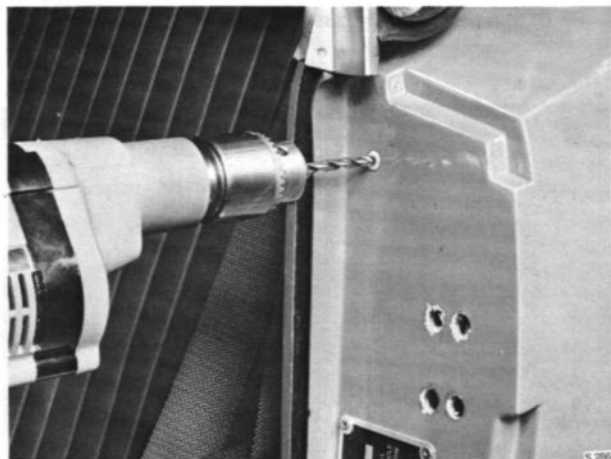

REMOVAL OF POP RIVETS ON REAR DOOR PILLARS

- b) Drill out the rivets holding the side-window frame to the body frame.

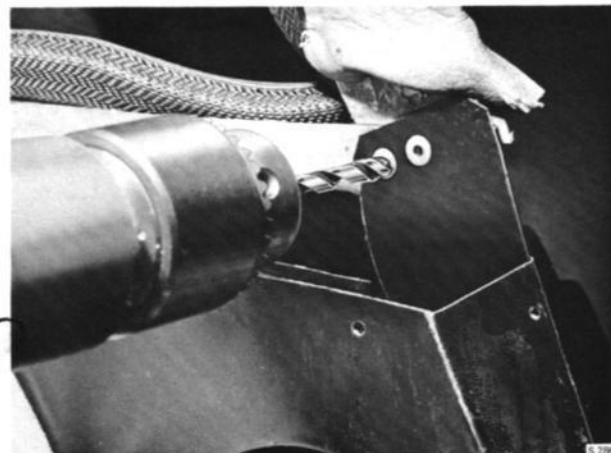

REMOVAL OF POP RIVETS AT OPENING SIDE WINDOWS

- c) Drill out the three uppermost pop rivets for the cover plates at the front door pillars.

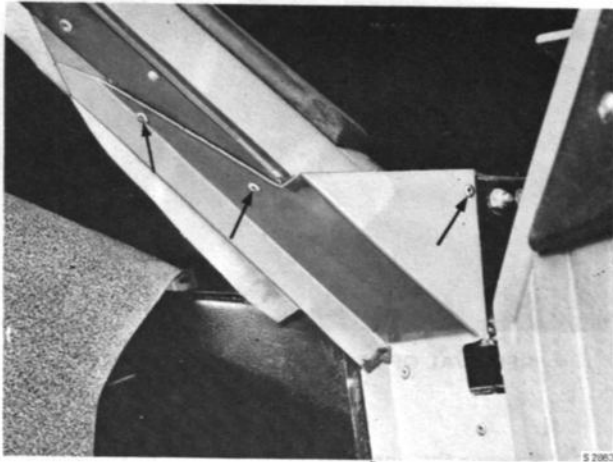

THREE POP RIVETS ARE TO BE REMOVED FROM THE FRONT DOOR PILLARS

13. Back off and remove the screws in the front edge of the rear wheel house, one on each side.

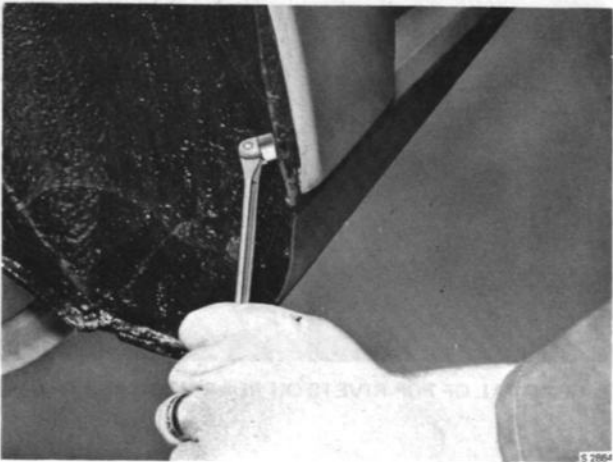

REMOVAL OF SCREWS IN FRONT EDGE OF REAR WHEEL HOUSE

14. Back off and remove the twelve screws round the front body attachment to the dash panel. The cover of the heater box must be removed.
15. Release the instrument panel, see section 850. Pull it out so that the support plates for the instrument panel are uncovered. Back off and remove the screws holding the windshield pillars to the dash panel (one on each side).



REMOVAL OF WINDSHIELD PILLAR RETAINING SCREWS

16. Pry loose the linkage between the windshield wiper motor and the wiper mechanism.
17. Cut away the sealing compound between the body and the chassis in the rear wheel houses, using a sharp knife.
18. Lift the body off upwards and rearwards.



THE BODY IS LIFTED OFF

Reassembly of body

1. Place the body on the frame and fit in the rear bumper screws. Lift up the rear part of the body and check the height with the aid of the middle stay. Refit the steel strip holding the body to the body frame at the rear, making sure that the vent hose does not get squeezed (model 1970). Tighten the nuts for the rear bumper and for the center stay.
2. Fix the body at the door pillars and front edge. Check with the aid of the doors that the body is properly positioned all over. Secure the body to the rear door pillar with a few pop rivets. Refit the screws at the windshield pillars and at the front edge of the rear wheel houses.

NOTE

The joints between body and body frame at the wheel houses and front edge must be thoroughly sealed with a suitable sealing compound, e.g. Rib-bonseal EC 2185, which is manufactured by the 3-M Company.

3. Refit the twelve screws round the front body attachment to the dash panel. Check that the distance between the upper side of the front plastic edge (in the center of the body) and the lower side of the sill is 625 mm (vertically). Refit the cover on the heater box.
4. Rivet the body on with the aid of a pair of pop rivet pliers at the rear door pillar (remaining rivets), the upper brackets for the cover plate on the front door pillar and the side window pillar.

NOTE

If a new body is to be fitted, it will be necessary to drill holes for the pop rivets.

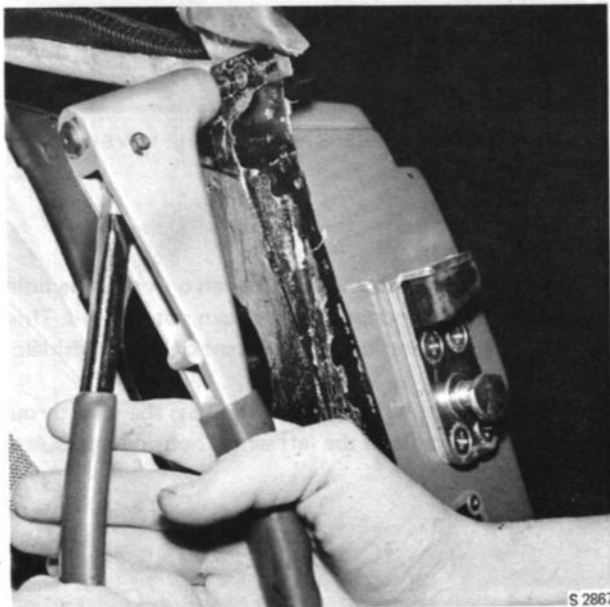

RIVETING WITH A POP RIVET TOOL

6. Fit the rear-window lock loosely and insert the control wire. Replace the insulation sheets at the rear.
7. Refit the filler pipe, the rubber ring and the tank cap. As from model 1971: Refit the vent hose for the fuel tank.
8. Refit the striker plates for the door locks. Hold the retaining plate on through the hole under the side lining.



FITTING THE STRIKER PLATE AND RETAINING PLATE

9. Refit the linings in the luggage compartment as well as the side linings behind the doors.
10. Refit the weather strips at the doors and opening side windows. Refit the side windows.
11. Position and secure the rear window. Apply sealing compound between the body and the hinges. Adjust the window locking device.
12. Refit the linkage between the windshield wiper motor and the wiper mechanism.
13. Refit the instrument panel.
14. Refit the hood. See section 820.
15. Reconnect the battery cable to the battery.

HOOD AND ENGINE LID

Engine lid

The lid is opened with a handle located to the left of the steering column. To remove the lid, unfasten the stay and the two screws. Collect the rubber washers and the spacer sleeves.

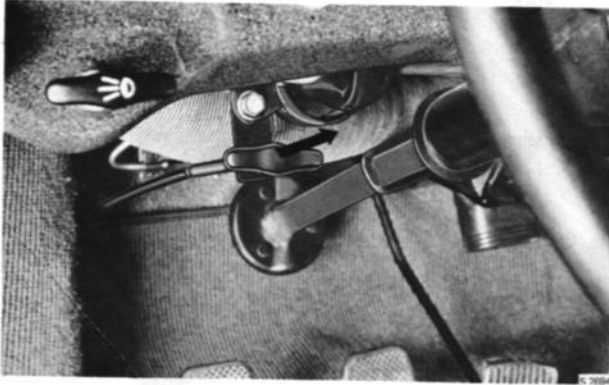

ENGINE LID RELEASE HANDLE

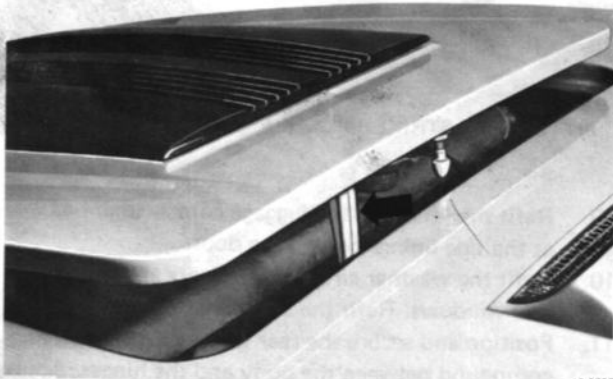

ENGINE LID LOCK

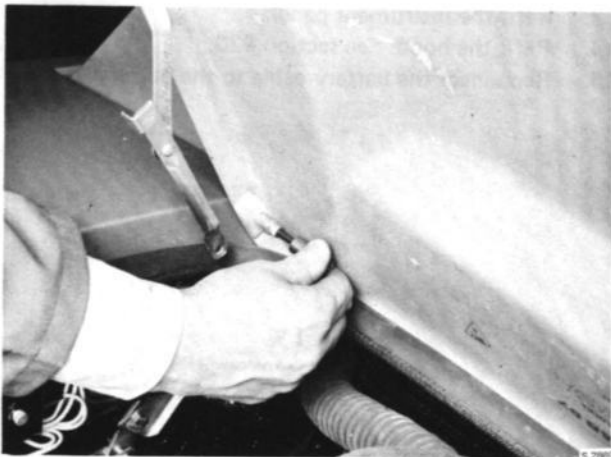

REMOVAL OF ENGINE LID

NOTE

If the wire in the engine lid release handle is broken, or if it has come loose, the lid can be opened by pressing up the lock with a suitable pin through a hole in the right wheel house. See illustrations (model 1970 only).

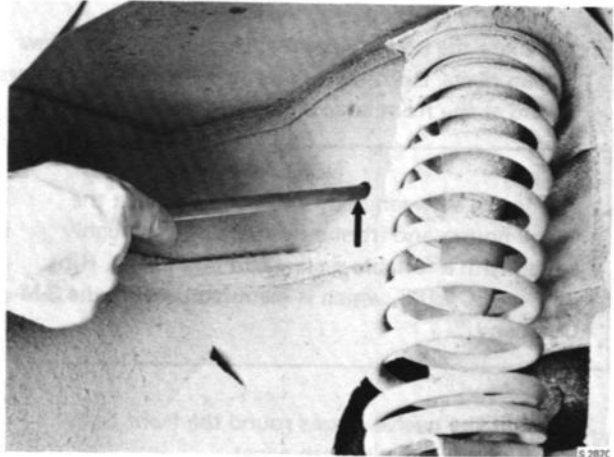

LOCATION OF HOLE, MODEL 1970

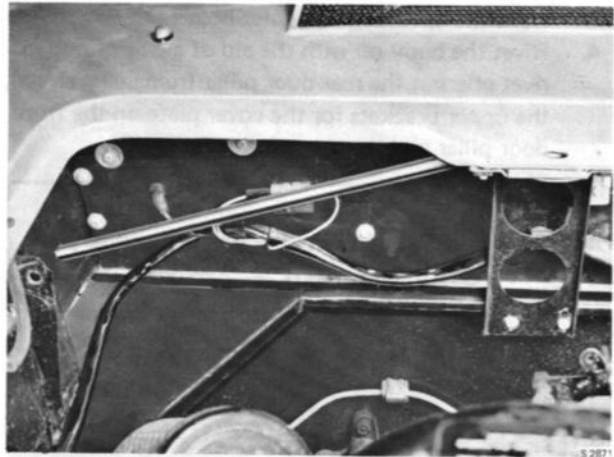

TO OPEN THE LOCK, PRESS AGAINST THE LEVER, MODEL 1970

As from model 1971:

If the engine lid control wire is broken or loose, the hole according to the description above can not be used. This because of the alteration in placement of the windshield wiper motor.

Instead use a bent, rather thick wire. Pass the wire through the steering rod hole in the left wheel housing and pull up the lock of the lid.

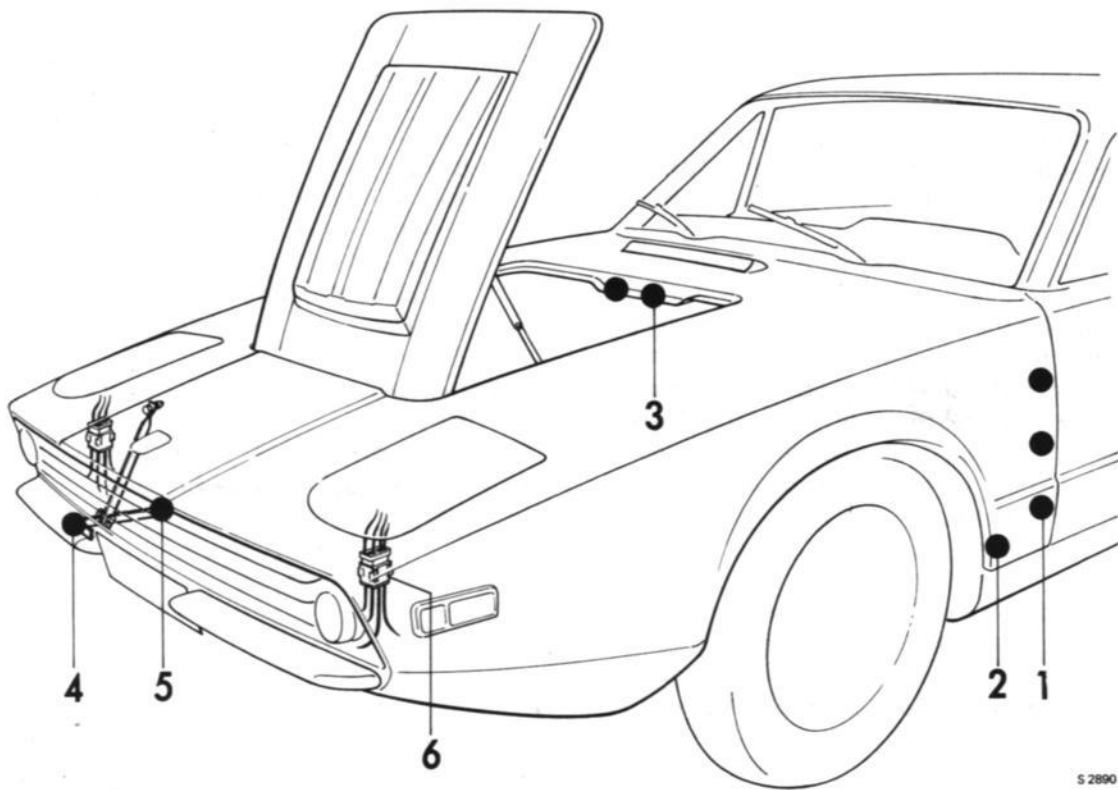

S 2890

HOOD ATTACHMENT POINTS, NUMBERS REFER TO THE TEXT

Hood

Removal

1. Back off and remove the screws (1) in the door pillars. (3 screws on each side).
2. Back off and remove the screws (2) in the wheel houses. (1 screw on each side).
3. Back off and remove the two screws (3) at the engine lid cover.
4. Back off and remove the two nuts (4) at the stay attachment to the bumper
5. Back off and remove the screws (5) at the hood attachment to the body frame. (1 screw on each side). Note the rubber washers between the hood and the body frame.
6. Remove and pull apart the two connection pieces (6) on both sides of the radiator.
7. Back off and remove the two screws for the headlight control. See fig.
8. Disconnect the windshield wiper hose from the pump. Lift the hood off forwards and upwards. Stand the hood on its rear edge.



REMOVAL OF HOOD



SCREWS, HEADLIGHT CONTROL

Installation

1. Place the hood on the body frame and adjust it into position at the points of attachment. Screw down the tensioning screws for the headlight holders. Make sure that the headlight mechanism will be correctly installed in its slot.
2. Screw in the screws at the door pillars without tightening them up.
3. Lift the hood at the front edge (use hand force in the rigid section above the grille) and at the same time insert two blocks, 60 mm (2 3/8") high and 60 mm (2 3/8") wide, between the hood and the frame over the radiator (as far outwards as possible). Insert the blocks through the two holes on the underside of the hood at the front edge.

NOTE

If use of the blocks is neglected, the hood will not get the correct position. This may cause that the cooling fan will hit the cross bar for the head lights and it may also make a proper head light adjustment impossible.

CAUTION

These blocks must on no account be forced into position, since this could result in damage to the hood.



BLOCKS INSERTED BETWEEN HOOD AND RADIATOR FRAME

4. Refit the front stay and the screw between the body frame and the headlight mechanism. First fit the front ends of the stays without tightening them up and then the rear ends.
5. Remove the blocks.
6. Refit all other screws and electrical connection pieces. Refit the weather strips and tighten up the screws at the door pillars. Check with the aid of the door that the rear edge of the hood is at the correct height. Minor errors can be dealt with by adjusting the door at the hinge hooks.
7. Refit the pullrod for the headlight mechanism to the mechanism.
8. Adjust the tension of the headlight holders and then align the headlights. See Group 3.

DOORS

The doors consist of a steel frame to which a plastic shell is riveted.

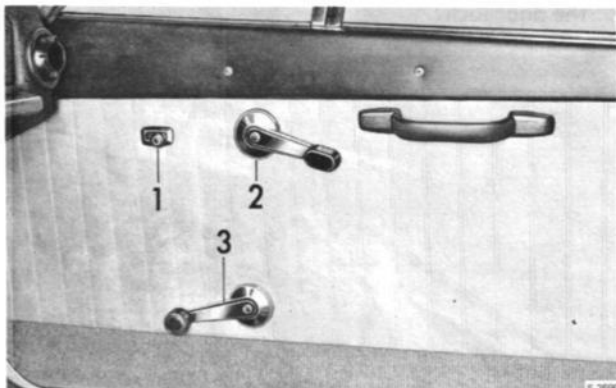

INSIDE OF DOOR UP TO AND INCL. MODEL 1972

1. Lock button
2. Door handle
3. Window crank

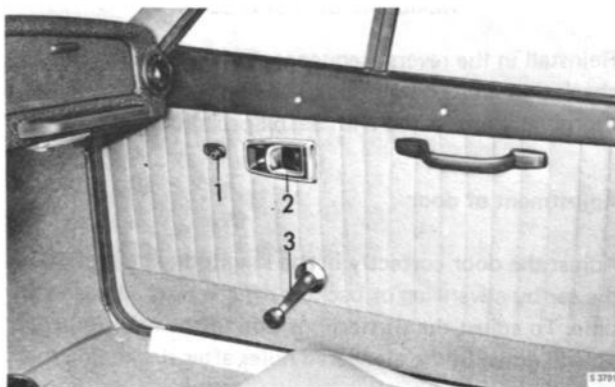

INSIDE OF DOOR AS FROM MODEL 1973

1. Lock button
2. Door handle
3. Window crank

Removal of door

1. Remove the door lining (see section 850.)
2. Prop the door up on a suitable support or suspend it in a suitable way so as to relieve the hinges of the weight of the door.
3. Back off and remove the two nuts which are accessible from inside the door and lift the door off.



REMOVAL OF DOOR

Installation

1. Prop up or suspend the door in the correct position and then pass it onto the pivot pins of the hinges.
2. Refit the washers and hinge nuts to the inside of the door.
3. Test cautiously to see if the door fits into the opening.

Replacement of door hinges

1. Lift off the door (see "Removal of door").
2. Lift off the hood (see "Removal of hood").
3. Strike out the hinge pins. Use a dolly if necessary.



REMOVAL OF DOOR HINGES

4. If the lower hinge is to be removed, the door stop will have to be detached first.
Remove the door stop by removing the lining from the inside of the wheel house. The cotter pin can then be removed through the hole and the door stop pulled out.
Fit the new hinge(s) in the reverse order.

Replacement of door stops

See "Replacement of door hinges".

Removal of window regulator

1. Remove the door window. See section 843.
2. Remove the U-shaped door-window bracket.
3. Back off and remove the window-regulator retaining screws and lift out the regulator.

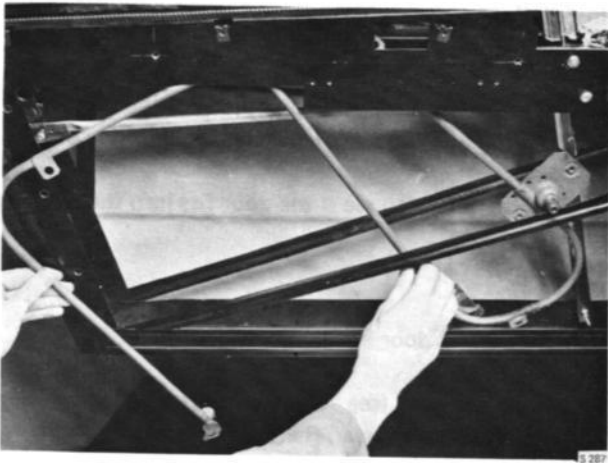

REMOVAL OF WINDOW REGULATOR

Reinstall in the reverse sequence.

Replacement of door lock

1. Close the door window properly.
2. Remove the door lining. See section 850.
3. a. Up to and incl. model 1972:
Screw off the door-lock remote control retainer.

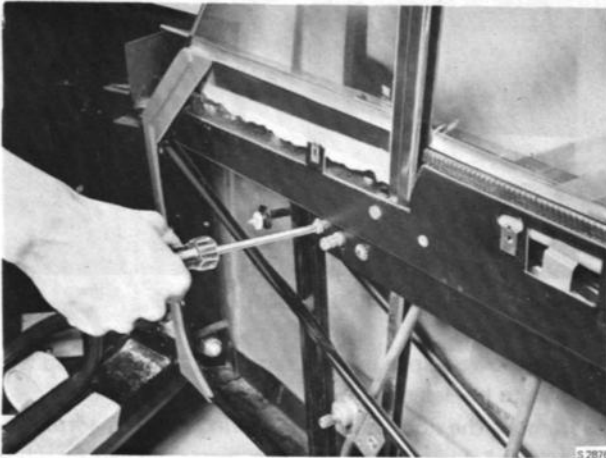

REMOVAL OF DOOR-LOCK REMOTE CONTROL RETAINER

- b. As from model 1973:
Undo and remove the three screws in the retaining plate of the inner door handle. Detach the link rod from the lock mechanism, by removing the screw and the bearing. Withdraw the handle and the link rod.

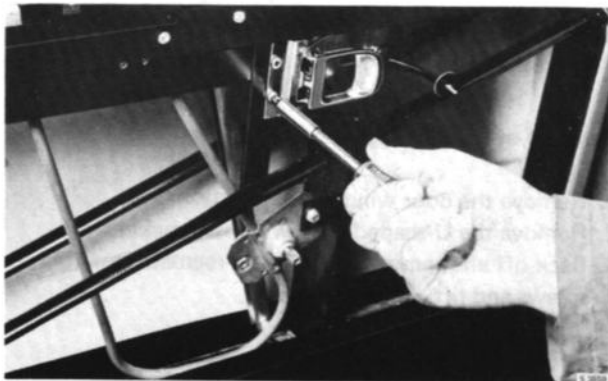

REMOVAL OF INNER DOOR HANDLE

4. Back off and remove the three door-lock retaining screws.
5. Release and remove the lock. If necessary, the control rod of the door locking catch can be removed from the door lock.



REMOVAL OF DOOR LOCK

Reinstall in the reverse sequence. Before refitting the lock, check that all its moving parts and lock springs have been thoroughly lubricated with Saab Special Grease.

Adjustment of door

Adjust the door correctly in the longitudinal direction of the car by advancing or backing off the nuts a little at a time. To adjust the vertical position of the door, move it up and down in the elongated holes after slackening the nuts slightly.

Adjustment of door striker plate

The striker plate is adjustable and can be moved when the screws are slackened. Adjust the striker plate so that it does not force the door up or down. At the same time, make sure that the door opens and closes easily.

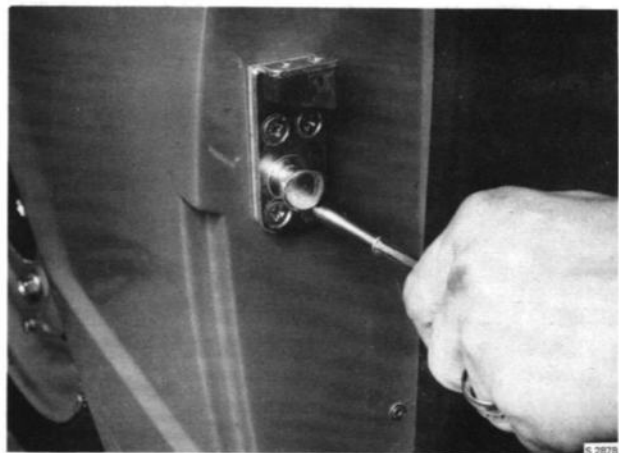

ADJUSTMENT OF DOOR STRIKER PLATE

Replacement of door striker plate

1. Back off and remove three of the retaining screws and slacken the fourth one slightly.
2. Move the striker plate aside and insert a screw in the retaining plate to prevent it from falling down.
3. Fit a new striker plate. Refit the screws and adjust the striker plate. Tighten up the screws.

Replacement of door lock cylinder

Model 1970:

1. Loosen the plastic shell on the door by drilling out the pop rivets on the rear and on the lower side. Remove the two door-lock screws.
2. Bend the plastic shell carefully outwards to provide access to the push button. Remove the circlip holding the washer.

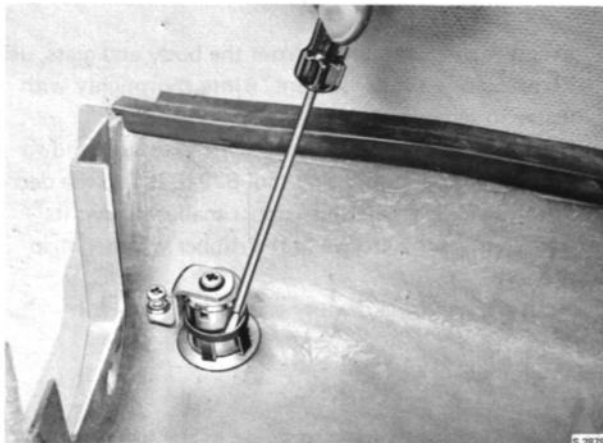

REMOVAL OF CIRCLIP FOR PUSHBUTTON

As from model 1971:

1. Remove the door lining.
2. Unscrew the nut from the sleeve.

Model 1970-1971:

3. Pull the pushbutton out slightly and detach the arm from the push button. The push button can now be removed.
4. Press the nickel-plated sleeve down in order to uncover the hole for the catch pin in the lock cylinder.
5. Insert the key and turn it 35° to the right, thus enabling the catch pin to be pressed in and the lock cylinder to be removed.

If the key has been lost, the catch pin can be driven into the lock cylinder by force, using a driver or pin with a diameter of max. 0.12 in. (3 mm), thus enabling the cylinder to be removed from the push button. This treatment, however, ruins the lock cylinder and a new one must therefore be fitted.

Reassembly takes place in the reverse sequence.

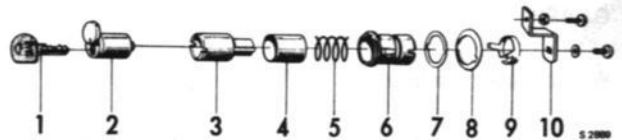

LOCK CYLINDER, EXPLODED VIEW, MODEL 1970

- | | |
|---------------------------|------------|
| 1. Key | 7. Gasket |
| 2. Lock cylinder | 8. Washer |
| 3. Pushbutton with sleeve | 9. Circlip |
| 4. Sleeve | 10. Driver |
| 5. Spring | |
| 6. Sleeve | |

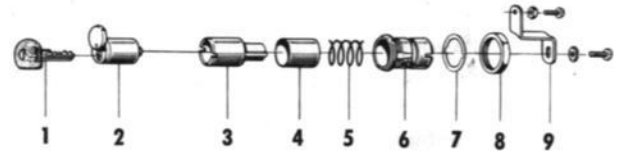

LOCK CYLINDER, EXPLODED VIEW, AS FROM MODEL 1971

- | | |
|---------------------------|-----------|
| 1. Key | 7. Gasket |
| 2. Lock cylinder | 8. Nut |
| 3. Pushbutton with sleeve | 9. Driver |
| 4. Sleeve | |
| 5. Spring | |
| 6. Sleeve | |

Keys

Four keys are supplied with the car. Two of them fit the ignition and steering wheel lock and the other two fit the doors. The serial number of the door key will be found under the rubber cap.

Spare parts

If a door lock cylinder is damaged, a new one can be ordered, in which case the key number and spare-part number must be quoted (see Spare Parts Catalogue). The system whereby the same key is used for both car doors can thus be retained without any necessity of replacing a complete lock kit.

Lubrication

If the lock cylinder is lubricated with oil or grease, it may happen that the lock pins get caught in the cylinder. The reason for this is that dirt adheres to the key and thus gets into the cylinder. Bearing this in mind, lubrication of the actual lock cylinder should be avoided.

If the key moves stiffly and the lock cylinder therefore has to be lubricated, a little glycerine may be smeared to the back of the key, whereafter the key should be turned back and forth a few times.

NOTE

Never apply lubricant to the indented side of the key.

GLASS

Window-glass, general

The windshield is made of laminated glass, whereas the other window panes are made of toughened glass. When installing a new windshield or windows, always use genuine Saab glass to ensure both approved quality and snug fitting.

Replacement of windshield

1. Remove the windshield-wiper arms.
2. Remove the decoration strip and press the windshield outwards with the hand from inside the car.
3. Clean the contact surface of the rubber weather strip on the body and remove all traces of old sealing compound.
4. Fit a new rubber weather strip to the body.
5. Bend and grind a chisel as shown in the sketch.

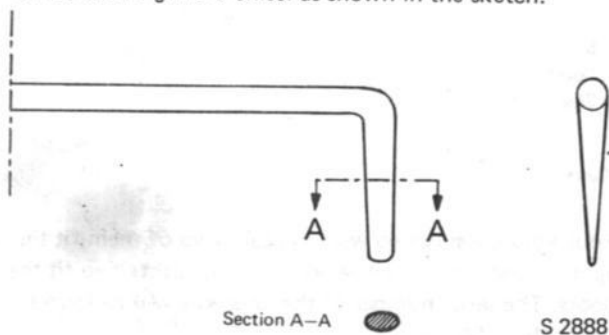

FITTING TOOL, WINDSHIELD

Note that there must be no sharp edges on the tool in order to eliminate the risk of scratching the windshield.

6. Place the windshield in the body in the groove on the lower edge of the rubber weather strip.
7. Pull the outside flange of the rubber weather strip over the edge of the windshield with the tool, meanwhile pressing the glass inwards. An assistant should press against the edge of the body from the inside.

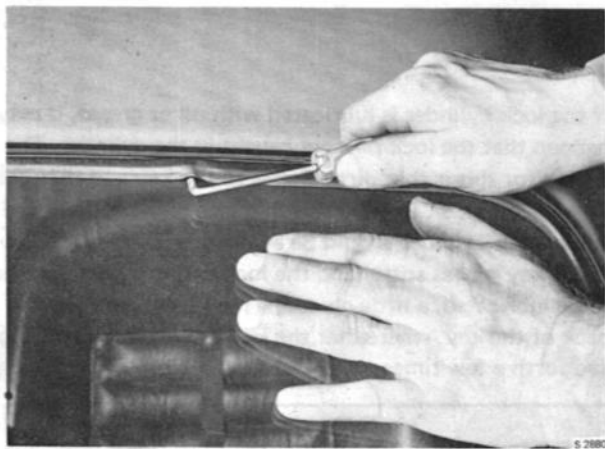

INSTALLATION OF WINDSHIELD

Inject sealing compound, e.g. Ribbonseal EC 2185, both between the rubber weather strip and the body and between the weather strip and the windshield. Remove

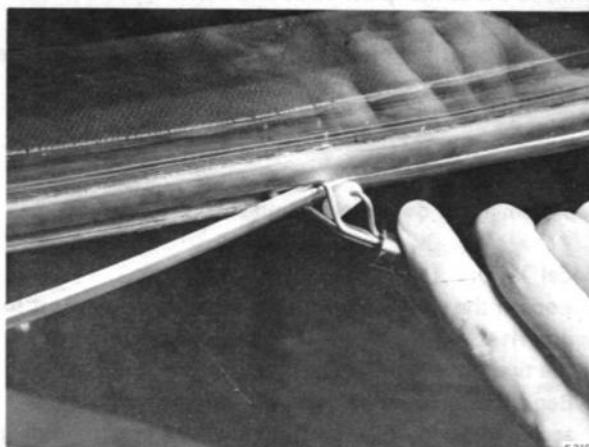

FITTING THE DECORATION STRIP

excess sealing compound from the body and glass, using kerosene or a similar solvent. Rinse thoroughly with water to remove all traces of the solvent.

Coat the rubber weather strip with soap suds and fit the decoration strip, using tool 829102. Tap the decoration strip lightly with a rubber mallet so that its flange enters the groove in the rubber weather strip properly.

8. Refit the windshield wiper arms.

Rear window

The rear window, which also serves as the luggage-compartment lid, is made of toughened glass. One part of the hinges is screwed directly to the glass and the other is attached with four screws through the roll bar and body roof.

The luggage-compartment lid is opened with a handle on the partition wall behind the left seat. Up to and incl. model 1972, the lid can be held open, by a stay on the left side.

As from model 1973, there are telescopic designed stays, retained in the hinges. The lid can therefore be put in the desired position, from closed to fully opened.

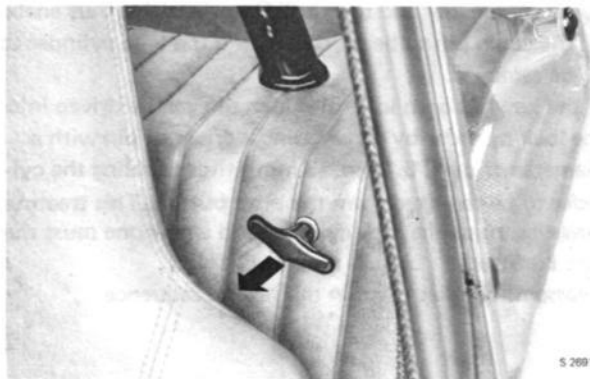

REAR-WINDOW HANDLE

The lid is removed by unfastening the two screws for the hinges.

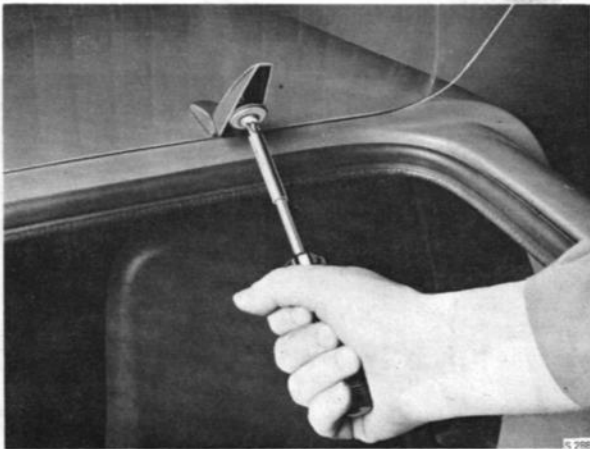

REMOVAL OF REAR WINDOW UP TO AND INCL. MODEL 1972

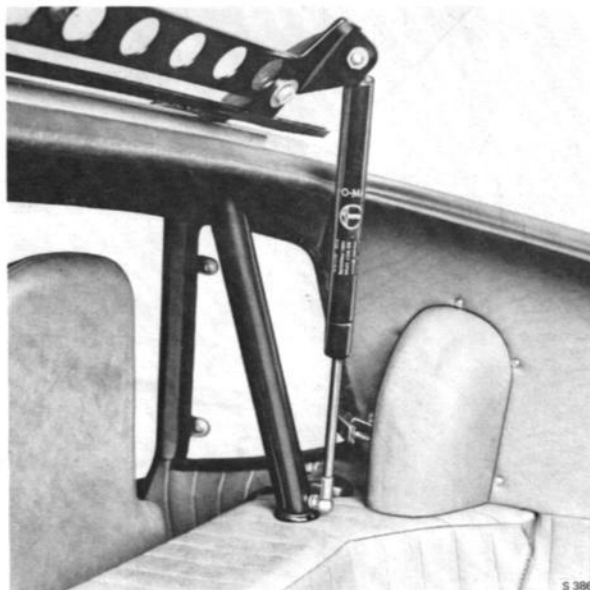

HINGES AND TELESCOPICAL STAY AT REAR WINDOW, AS FROM MODEL 1973

Replacement of opening door windows

Removal

1. Remove the door lining. See section 850.
2. Drill out the pop rivets in the rear part of the plastic door shell and back off two of the screws retaining the door lock so that the plastic shell can be bent to one side.
3. Back off and remove the retaining screws for the rear run channel and pull it out of the door.
4. Detach the door-window fastening from the U-shaped retainer channel.
5. Pull the window glass up and lift it out.

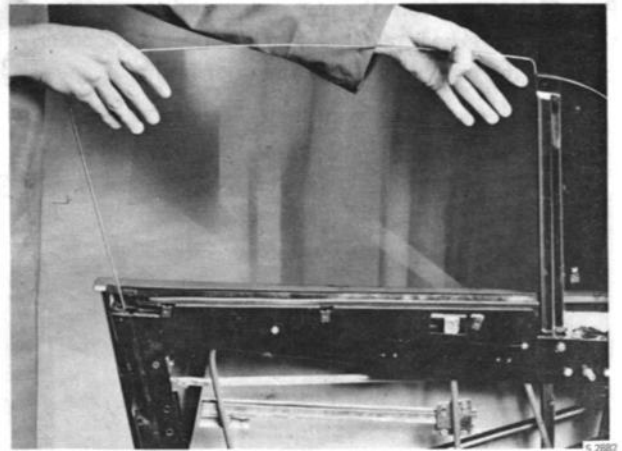

REMOVAL OF DOOR-WINDOW GLASS

Installation

1. Lift the glass in and press it firmly into the retainer channel.
2. Refit the rear run channel. Make sure that the window moves smoothly in the run channels.
3. Rivet the plastic door shell on, using a pop-rivet tool, and refit the screws for the door lock.
4. Refit the door lining.

Replacement fixed glass, door

1. Remove the door. See section 830.
2. Drill out the pop rivets and remove the plastic door shell from the door frame.
3. Model 1970:
Drill out the pop rivets for the sealing strip. Pry off the U-shaped retainer channel from the door frame and the glass off from the rear sealing. Remove the glass together with the retainer channel and sealing strip. Collect the spacers between the retainer channel and door frame.

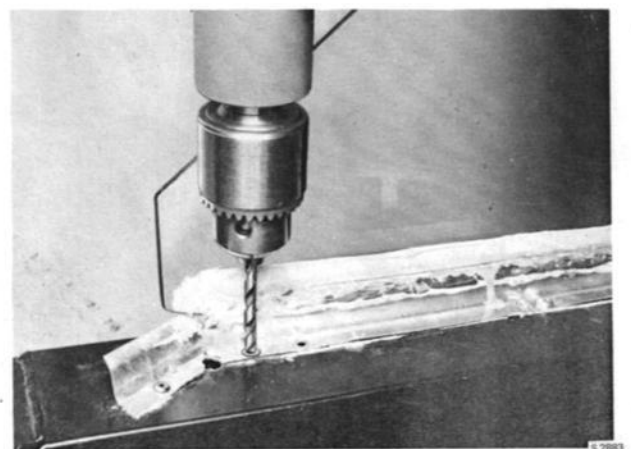

REMOVAL OF POP RIVETS FROM SEALING STRIP, MODEL 1970

3. As from model 1971:
Drill out the pop rivet and remove the two nuts for the retainer channel. These nuts are accessible from inside the door frame.

Pry off the glass from the rear sealing and remove it together with the retainer channel. Collect the spacers between the retainer channel and door frame.

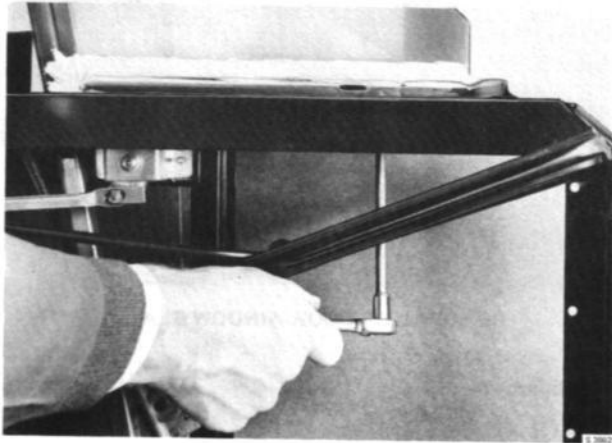

REMOVAL OF NUTS FOR THE RETAINER CHANNEL, AS FROM MODEL 1971

Installation

1. Fit a new retainer channel to the door frame and fill it with a suitable adhesion compound, e.g. Epoxy resin.
As from model 1971:
The joint between the retainer channel and door frame must be sealed with suitable sealing compound.
2. Fit the window glass into the U-shaped retainer channel and press it into the rear sealing.
3. Model 1970:
Fit a new sealing strip, attaching it with pop rivets or self-tapping screws. Seal the joint at the top with a suitable sealing compound, e.g. Epoxy resin.
4. Reattach the plastic door shell with pop rivets.
5. Refit the door.

Opening side windows

To remove the side windows, back off and remove the three screws retaining the locking mechanism and then unhook the window from the "hinges".

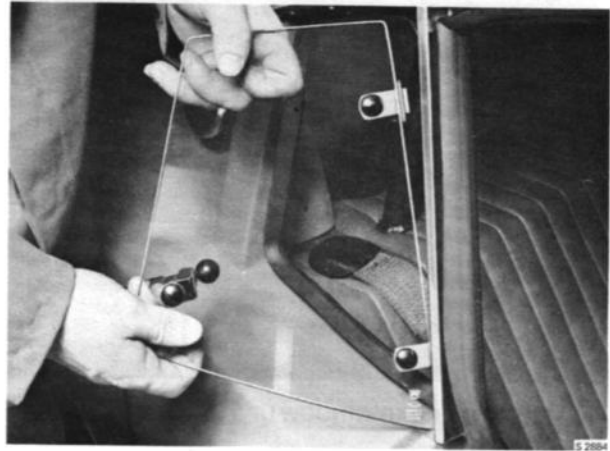

REMOVAL OF OPENING SIDE WINDOW

LININGS AND INTERIOR FITTINGS

Door lining

Removal

1. a. Up to and incl. model 1972:
Back off and remove the screws for the window regulator and for the inside door-lock handle. Unscrew the lock button.
b. As from model 1973:
Back off and remove the screw for the window regulator. Unscrew the lock button. Bend out the front edge of the inner handle cover plate and then remove it.
2. Take off the plastic protectors for the door handle with the aid of a screwdriver. Back off and remove the four screws.
3. Back off and remove all the screws holding the door strip.
4. Carefully open the clips holding the door lining and remove the lining.

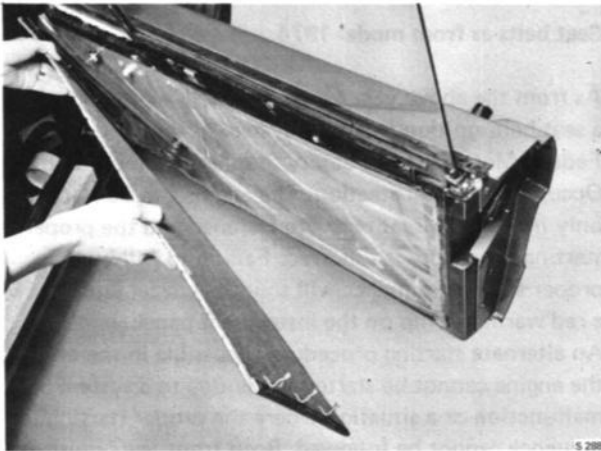

REMOVAL OF DOOR LINING

Note the spring behind the crank of the window regulator.

Reinstall in the reverse order.

Headlining

The headlining is glued to the body.

Other linings

The rear and side linings of the luggage compartment are attached with self-tapping screws. All other linings are glued on.

If the lining on the partition wall behind the seats is to be renewed, it will be necessary to remove the roll bar. See section 850.

Mats

The floor mats consist of carpeting made of synthetic fiber on a jute-fabric backing. Underneath the front mat are insulation sheets of wallboard, to which the mat is attached with bur fastenings. The rear mat is fitted directly to the floor.

The luggage-compartment mat is glued to the floor cover.

Seats

The seats are built on a frame of fiberglass-reinforced plastic. The seat, backrest and head restraint are made as an integral moulding. The backrests are provided with an adjustable cushion. The seats are upholstered with nylon corduroy cloth. (The luxury version has leather upholstery.) The seats are fitted in slide rails and are thus adjustable for legroom.

Legroom adjustment

Lift the catch (see illustration) and slide the seat forwards or rearwards to the desired position.

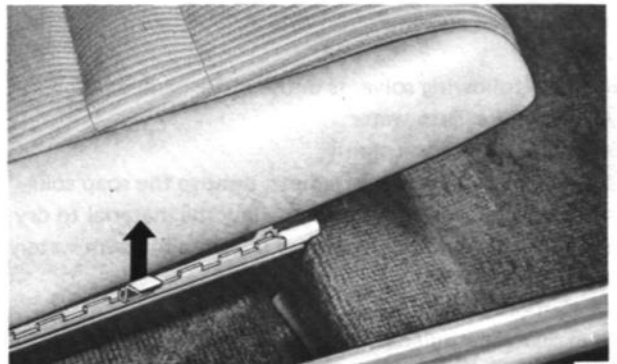

SEAT ADJUSTMENT CATCH

Removal of seat

Lift the legroom-adjustment catch and slide the seat forwards until the seat rails are clear of the floor rails. The seat can then be removed.

The seat floor rails should be inspected at regular intervals to make sure that the screws are firmly tightened and that the rails are not laterally displaced. If the seats move stiffly, the upper rails should be smeared with a little Saab Special Grease.

Cleaning upholstery

When attempting to remove stains from fabrics of any kind it is recommended that the area adjacent to the stain first be moistened with the solvent before working on the stain itself. Otherwise, a soil ring may be left around the cleaned spot.

Specific stains

Grease, oil and lipstick can be removed with carbon tetrachloride. Large stains are best dealt with by moistening in the normal manner and then pouring solvent over the entire stain and soaking it up with blotting paper. Chocolate, ice-cream, fruit and vomit stains should be treated initially with lukewarm water, possibly with the addition of a little soap solution. After drying, any residual stains may be removed with carbon tetrachloride.

Battery acid should be treated instantly with large quantities of cold water, as otherwise the acid may burn holes in the upholstery. If possible, add a few drops of ammoniac to the first water.

Blood stains should never be allowed to dry, but should be removed immediately with cold water.

Unidentified stains

Try the following solvents in the order named:

Cold or lukewarm water

Lukewarm soap solution

Before making further attempts, remove the soap solution with lukewarm water and allow the material to dry, since the following solvents are not miscible with water.

Continue with

Carbon tetrachloride

Trichloroethylene

Pure gasoline

Rub the spot while the solvent evaporates, first hard and gradually more gently as evaporation continues.

Do not forget the initial moistening round the stain. The bigger the stain, the bigger the area to be moistened.

Lighter fluid can be used instead of carbon tetrachloride.

Cleaning plasticized fabrics

Plasticized fabrics are impermeable to dirt, being completely dust-tight and proof against oil and gasoline. A dirty plastic surface can easily be cleaned by washing with water and a synthetic detergent. Large oil stains, etc., can be treated with white spirit, trichloroethylene and similar solvents. Such organic solvents, however, should not be used too frequently, as they tend to cause stiffness in the plastic.

Seat belts model 1972-1972

The belt consists of a lap belt which is adjusted automatically by a retractor mechanism and a shoulder belt which is adjusted manually by the driver or passenger. If the driver or passenger forgets to use the seat belt, a buzzer will be heard and a red warning lamp, displaying the words FASTEN SEAT BELTS will light up on the instrument panel as soon as the ignition is switched on and a gear is engaged.

Seat belts as from model 1974

As from the above year model the car is equipped with a seat belt/ignition interlock system as required by Federal Motor Vehicle Safety Standard Number 208 - Occupant Crash Protection. The engine can be started only if the front seat belts are fastened and the proper starting procedure is followed. Failure to follow the proper starting sequence will sound a buzzer and light a red warning lamp on the instrument panel.

An alternate starting procedure is possible in the event the engine cannot be started either due to a system malfunction or a situation where the proper starting sequence cannot be followed. Both front seats must be unoccupied. The ignition switch should then be turned from garage position ('G') to the start position ('S') while reaching over the seat.

WARNING

Do not place heavy objects on the passenger seat as they will make the engine impossible to start.

No alterations or additions should be made to this belt system.

The webbing must not be bleached or re-dyed.

The belt is meant for one person only.

The shoulder belt and lap belt must be used together (valid for model 1972-1973).

Instrument panel

Detachment

1. Back off and remove the four screws holding the instrument insert. Pass the speedometer cable in from the direction of the engine compartment. Remove the instrument insert.
2. Back off and remove the screw for the rear bracket holding the instrument panel to the front edge of the body.

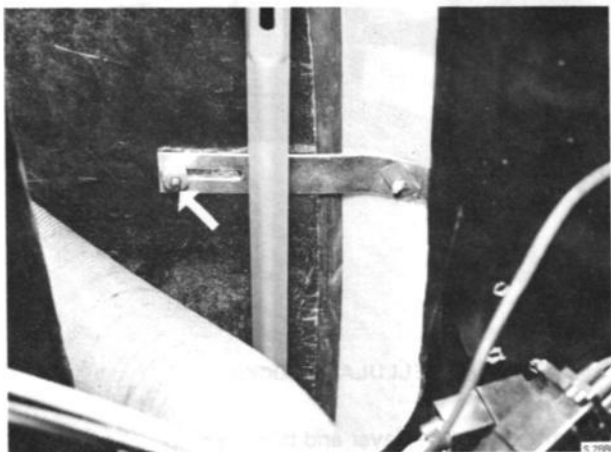

SCREW TO BE REMOVED WHEN DETACHING THE INSTRUMENT PANEL

3. Back off and remove the four screws holding the instrument panel to the dash-panel support member.

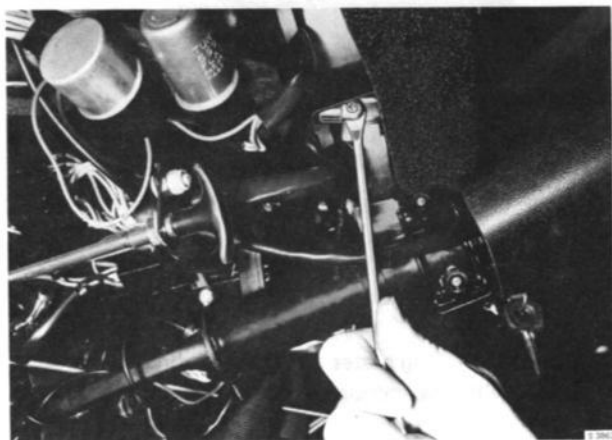

REMOVAL OF SCREWS, INSTRUMENT PANEL

4. Remove the ash-tray bracket.
5. Detach the heater-control wires from the dampers and thermostat valve and remove the headlight-control handle.
6. Pull the instrument panel out.

Removal of instrument panel

1. Detach the panel as described above.
2. Remove the steering wheel. See "Removal of steering wheel".
3. Disconnect all cables and heating hoses and remove the instrument panel.

Reinstall in the reverse order.

Roll-over bar

Removal

1. Back off and remove the four screws for the rear-window hinges.
2. Remove the lining from the partition wall and back off and remove the two roll-bar retaining screws. The roll bar can now be removed.

Reinstall in the reverse order.



REMOVAL OF ROLL-OVER BAR RETAINING SCREWS

BUMPERS AND GRILLE

Bumpers up to and incl. model 1972

The bumpers are made of polyurethane foam with a supporting bar of steel and are moulded in one piece. The front bumper is attached to the hood by means of four nuts, which are accessible from underneath.

The rear bumper is attached to the body with six nuts. Four of these nuts are accessible after removal of rear linings and insulation sheets in the luggage compartment. The other two nuts are accessible from each wheel housing.

Bumpers, as from model 1973

General

The shells of the bumpers consist of U-shaped steel bars to which the bumper brackets are welded. There are shock-absorbant cellular blocks of polyethylene in the bars. Outside the blocks there are polyethylene braces and the bumpers are coated with a layer of rubber. This layer is provided with anchorage bars on the inside and with a stainless steel bracing strip on the outside. Provision has been made on the front bumper for the attachment of license plates and additional lights.

The bumpers is mounted with two brackets to the body.



BUMPER

Removal

The bumpers are removed by undoing the two screws at the bumper brackets.

Changing the cellular blocks

1. Remove the bumper.
2. Remove the bracing strip. Note the spacing sleeves under the filling plates at each end of the bracing strip.
3. Remove the anchorage bars on the side of the bumper where the cellular block is to be changed.
4. Pull off the rubber layer, after which the cellular blocks are accessible and can be removed.

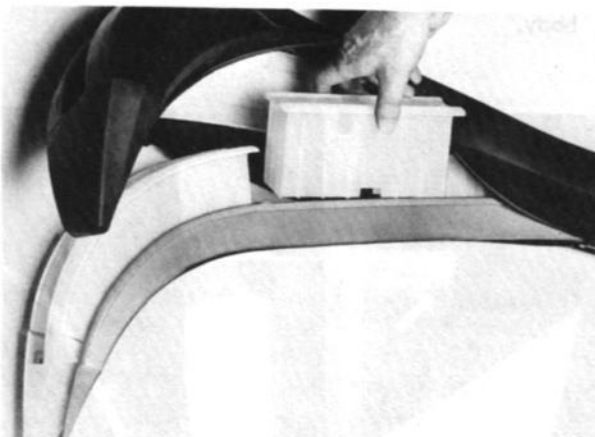

CHANGING THE CELLULAR BLOCKS

5. Refit the rubber layer and bracing strip.

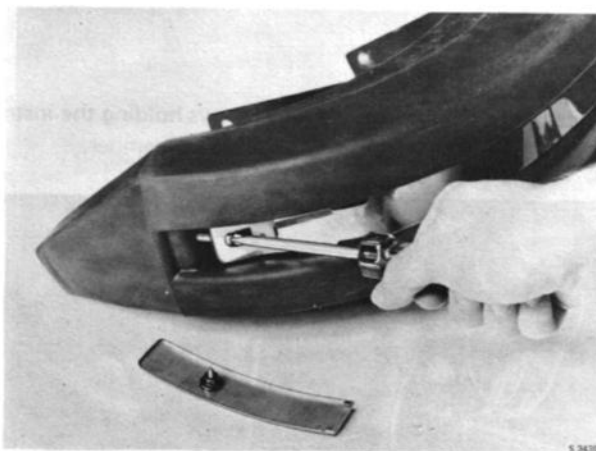

MOUNTING THE BRACING STRIP

6. Mount the filling plates and their spacing sleeves together with the anchorage bars. Remount the bumper.

Grille

The grille is attached to the front edge of the hood with screws accessible from outside and nuts accessible from underneath.

BODY FINISHING

General

The Sonett III is painted with a two-component polyurethane lacquer. The lacquer is delivered with a separate hardener and the two components are mixed immediately before use and diluted to a sprayable viscosity with thinner. The ready-mixed paint can then be used for about four hours. The paint hardens in two or three hours at room temperature; after 16 hours it is bone dry and can be polished. It takes about a week, however, for the paint to attain its ultimate optimum film properties.

The hardening process can be accelerated by the use of elevated temperatures; the paintwork can be polished after drying for one hour at 80°C (176°F) and cooling to room temperature.

Where more than one coat is applied, not more than 24 hours should elapse between applications. After any longer interval the surface should be ground to improve adhesion between the coats.

Painting new body parts (two coats)

NOTE

With Sadolin & Holmblad series 107 lacquer, use hardener No. 871-0138 and Aerogloss thinner No. 804-0103.

With Nordsjö 56197- lacquer, use hardener VV-13 and thinner DT 96.

Preparation

Wash the bodywork with thinner.

Lacquer

Before using, mix the lacquer and hardener in the proportions: 2 parts Lacquer to 1 part Hardener and dilute with Thinner, taking care to measure the proportions of lacquer and hardener accurately. Do not mix more than you are likely to use within about four hours. The bodywork must be perfectly dry before you start painting.

Spraying

Spray three times wet on wet at a viscosity of 18-19 sec/Frikmar 4/20°C (atomiser pressure about 2 bar, 28.5 psi).

Drying

Air for 10 minutes, then oven-dry for 50 minutes at 80°C (176°F).

Grinding

When the bodywork has cooled off, fill any holes with polyester filler and then go over the whole surface with No. 400 grinding paper. After grinding, allow the surface to dry thoroughly before applying the next coat of paint.

Spraying

Spray twice wet on wet at a viscosity of 16-17 sec/Frikmar 4/20°C (atomiser pressure 2 bar, 28.5 psi).

Drying

Air for 10 minutes, then oven-dry for 1 hour at 80°C (176°F).

Equipment cleaning

Clean the spray gun and other painting equipment immediately after use with Sado Thinner No. 803-0208. Aerogloss Thinner is not suitable for equipment cleaning.

Finishing

If there are any defects in the paintwork finish after the last coat has been applied (if the paint has run or picked up dust), it may be possible to correct these defects as follows:

1. Allow the bodywork to dry thoroughly (see under "Drying" above).
2. Allow to cool thoroughly (about 1 hour), then wet-grind the defective areas lightly with No. 600 paper.
3. Machine-polish the ground areas of the paintwork with fine grinding paste followed by Slipol No. 840-0025 until all abrasion marks have been removed.
4. Finally machine-polish the whole surface (right out to the edge) with Slipoline No. 840-0040.

Touch-up paint

Repainting areas of bodywork to a natural boundary

1. Wet-grind the whole surface thoroughly with No. 600 paper.
2. Fill any holes and pores with polyester filler.
3. Allow the polyester filler to dry.
4. Wet-grind the polyester filler, finishing with No. 600 paper.
5. Allow to dry after grinding.
6. Mix the lacquer and hardener in the proportions 2 parts Lacquer to 1 part Hardener and dilute to a sprayable viscosity with Thinner, taking care to measure the proportions of lacquer and hardener accurately. Spray two or three times wet on wet at a viscosity of 16–17 sec/Frikmar 4/20°C.
7. The paint will be dry to the touch in two or three hours. Polishing, if required, should be left until the next day (allowing about 16 hours for thorough drying). Drying can however be forced by using the oven; after one hour at 80°C (176°F) the paintwork will be bone dry and can be polished as described under "Touching-up" below when it has cooled off.
8. Clean the spray gun and other painting equipment immediately after use with Sado Thinner No. 803–0208. Aerogloss Thinner is not suitable for equipment cleaning.
8. Allow the paint to dry overnight or for one hour at 80°C (176°F).
9. Machine-polish with fine abrasive followed by Slipol No. 840–0025 until all abrasion marks have been removed. Finish by machine polishing with Slipoline No. 840–0040 all over the surface, right out to the edges.
10. Clean the spray gun and other painting equipment immediately with Sado Thinner No. 802–0208. Aerogloss Thinner is **not** suitable for equipment cleaning.

Touching-up

Touching-up should preferably be avoided, but if needed on secondary surfaces it can be done as follows:

1. Wet-grind the damaged spot thoroughly with No. 400 paper.
2. Fill any holes and pores with polyester filler.
3. Allow the polyester filler to dry.
4. Wet-grind the polyester filler, finishing with No. 600 paper. Grind an area round the damaged spot; this area must be big enough to avoid having to spray on unground paintwork.
5. Allow to dry after grinding.
6. Mix the lacquer and hardener in the proportions 2 parts Lacquer to 1 part Hardener and dilute to a sprayable viscosity with Thinner, taking care to measure the proportions between lacquer and hardener accurately. Spray two or three times wet on wet at a viscosity of 16–17 sec/Frikmar 4/20°C. Before the lacquer has time to stiffen after the last application, spray the touched-up area and boundary zones with Thinner.

CONTENTS

900	Description
911	Instruments
920	Accessories, mechanical*
930	Accessories, electrical
941	Heating and ventilation system

*) See Service Manual Saab V4.

CONTENTS

Introduction 1
The Agricultural Experiment Station 2
The Agricultural Experiment Station 3
The Agricultural Experiment Station 4
The Agricultural Experiment Station 5

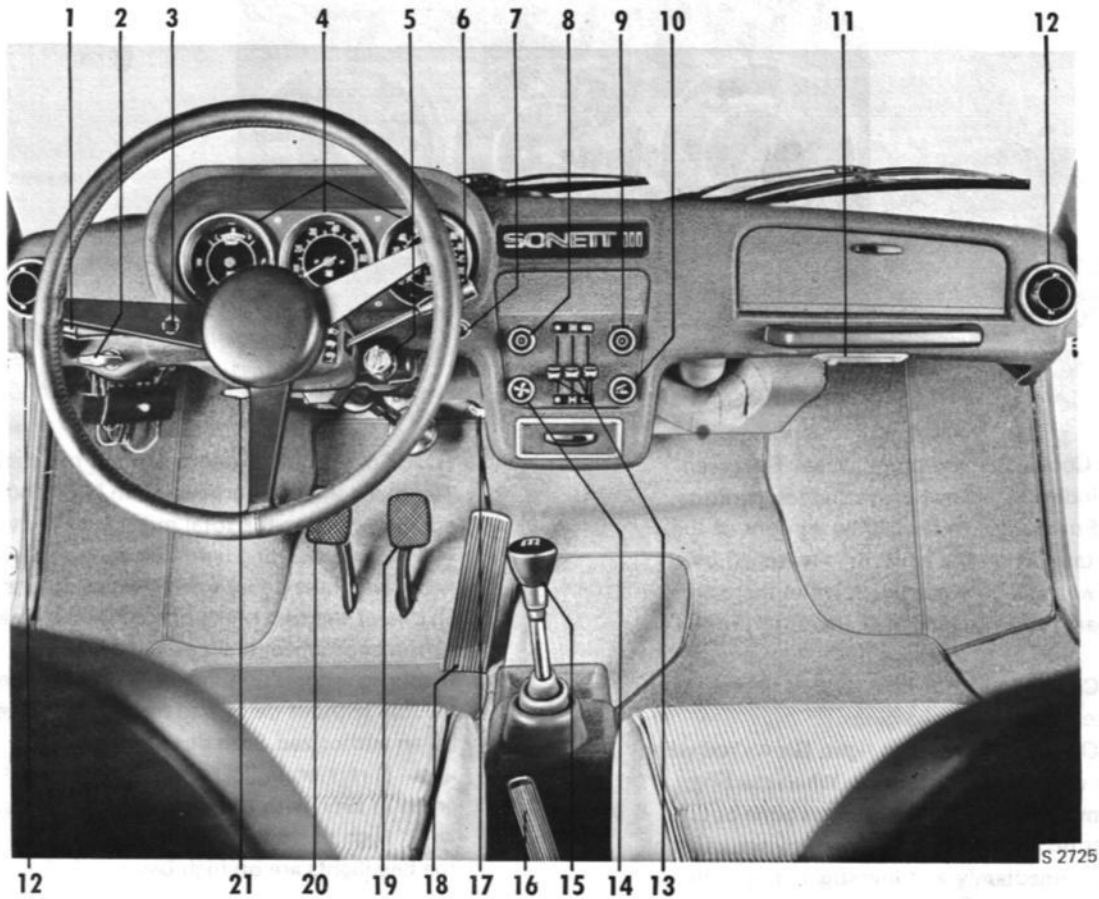

CONTROLS AND INSTRUMENTS, MODEL 1970

CONTROLS AND INSTRUMENTS

- | | |
|--|--|
| <ol style="list-style-type: none"> 1. Combined direction indicator lever and headlight dimmer switch 2. Headlight control 3. Instrument lighting rheostat 4. Instruments and indicator lights 5. Combined ignition switch and steering wheel lock 6. Windshield wiper/washer control and signal horn lever 7. Hazard warning signal switch 8. Parking light switch 9. Switch for extra lights | <ol style="list-style-type: none"> 10. Cigarette lighter 11. Map reading light 12. Adjustable fresh-air vents 13. Heating and ventilation controls 14. Ventilator fan switch 15. Gear lever 16. Handbrake 17. Free wheel drive control 18. Accelerator 19. Brake pedal 20. Clutch pedal 21. Engine hood lid lock release handle. |
|--|--|

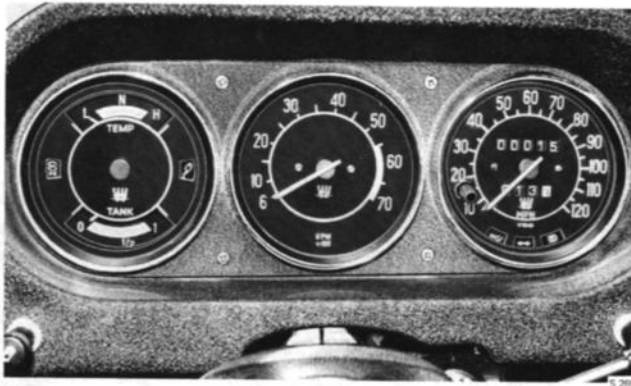

INSTRUMENTS AND INDICATOR LIGHTS, MODEL 1970

TEMP Coolant temperature gauge. The green zone indicates normal operating temperature.

TANK Fuel gauge. Indicates the amount of fuel in the tank when the ignition is switched on. A red warning light comes on when there are less than 1 3/4 US gallons (7 liters) left in the tank.

 Charge indicator light. Glows orange when the alternator is not charging.

 Oil pressure warning light. Glows red when engine oil pressure is too low. When starting, never move off until this light has gone out. If it lights up when you are driving, switch off the engine immediately and investigate the cause.

UPM Tachometer. The electric tachometer is coupled to the LT circuit of the ignition system.

MPH Speedometer, odometer and trip meter.

The speedometer is graduated in MPH and the odometer shows the total mileage of the vehicle.

 Brake warning light. Glows red to indicate excessive brake pedal stroke, which means
a) one of the two brake line circuits is leaking, or
b) the back wheel brakes need adjusting.

If this light comes on, investigate the cause of the trouble without delay and have the fault repaired by an authorized Saab dealer.

 Direction indicator repeater light. Flashes green in time with the direction indicators.

 High beam warning light. Glows blue when the headlights are on high beam.

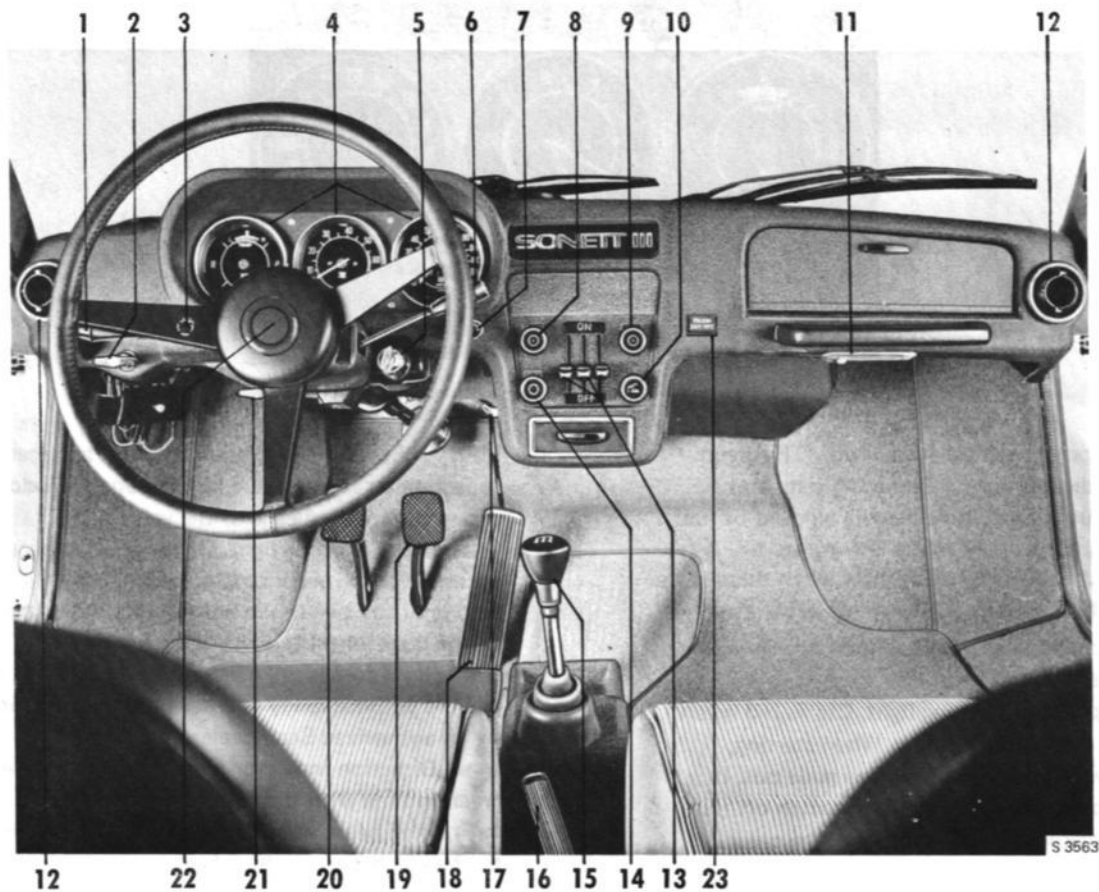

CONTROLS AND INSTRUMENTS MODEL 1971-1972

- | | |
|---|--------------------------------------|
| 1. Combined direction indicator lever and headlight dimmer switch | 12. Adjustable fresh-air vents |
| 2. Headlight control | 13. Heating and ventilation controls |
| 3. Instrument lighting rheostat | 14. Ventilator fan switch |
| 4. Instruments and indicator lights | 15. Gear lever |
| 5. Combined ignition switch and steering wheel lock | 16. Handbrake |
| 6. Windshield wiper and washer control | 17. Free wheel drive control |
| 7. Hazard warning signal switch | 18. Accelerator |
| 8. Parking light switch | 19. Brake pedal |
| 9. Switch for extra lights | 20. Clutch pedal |
| 10. Cigarette lighter | 21. Hood lock lid release handle |
| 11. Map reading light | 22. Horn control |
| | 23. Seat belt warning light |

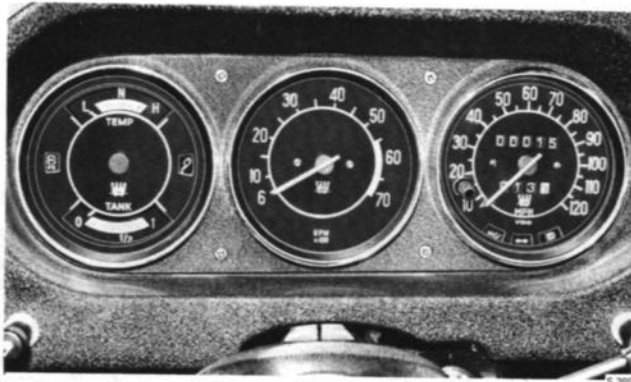

INSTRUMENTS AND INDICATOR LIGHTS, MODELS 1971-1972

TEMP Coolant temperature gauge. The green zone indicates normal operating temperature.

TANK Fuel gauge. Indicates the amount of fuel in the tank when the ignition is switched on. A red warning light shows a steady glow when there is less than 1 3/4 US gallons (7 liters) left in the tank.

 Charge indicator light. Glows orange when the alternator is not charging.

 Oil pressure warning light. Glows red when engine oil pressure is too low. When starting, never move off until this light has gone out. If it lights up when you are driving, switch off the engine immediately and investigate the cause.

UPM Tachometer.

MPH Speedometer, odometer and trip meter. The speedometer is graduated in MPH and the odometer shows the total mileage of the vehicle.

 Brake warning light. Glows red to indicate excessive brake pedal stroke, which means a) one of the two brake line circuits is leaking, or b) the back wheel brakes need adjusting.

If this light comes on, investigate the cause of the trouble without delay and have the fault repaired by an authorized Saab dealer.

 Direction indicator repeater light. Flashes green in time with the direction indicators.

 High beam warning light. Glows blue when the headlights are on high beam.

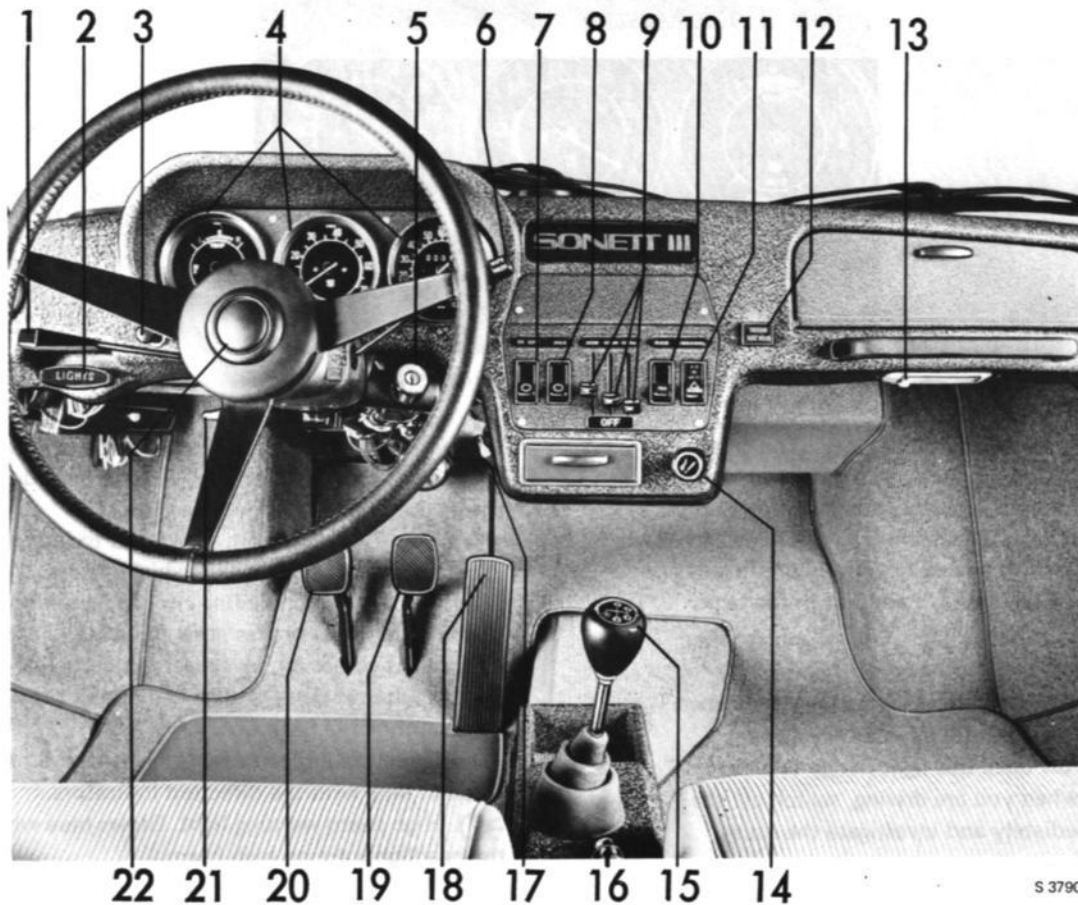

CONTROLS AND INSTRUMENTS AS FROM MODEL 1973

- | | |
|--|----------------------------------|
| 1. Combined direction indicator lever and headlight dimmer switch. | 11. Hazard warning signal switch |
| 2. Headlight control | 12. Seat belt warning light |
| 3. Instrument lighting rheostat | 13. Interior light |
| 4. Instruments and indicator lights | 14. Cigarette lighter |
| 5. Combined ignition switch and steering wheel lock | 15. Gear lever |
| 6. Windshield wiper and washer control | 16. Handbrake |
| 7. Parking light switch | 17. Free wheel drive control |
| 8. Switch for extra equipment | 18. Accelerator |
| 9. Heating and ventilation controls
Adjustable fresh-air vents | 19. Brake pedal |
| 10. Ventilator fan switch | 20. Clutch pedal |
| | 21. Hood lock lid release handle |
| | 22. Horn control |

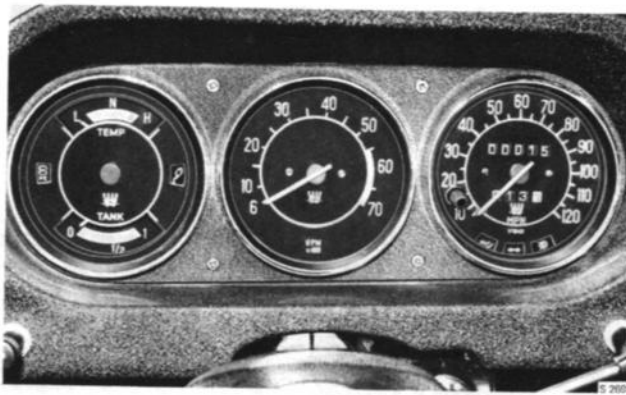

INSTRUMENTS AND INDICATOR LIGHTS, AS FROM
MODEL 1973

TEMP Coolant temperature gauge. The green zone indicates normal operating temperature.

TANK Fuel gauge. Indicates the amount of fuel in the tank when the ignition is switched on. A red warning light shows a steady glow when there is less than 1 3/4 US gallons (7 liters) left in the tank.

 Charge indicator light. Glows orange when the alternator is not charging.

 Oil pressure warning light. Glows red when engine oil pressure is too low. When starting, never move off until this light has gone out. If it lights up when you are driving, switch off the engine immediately and investigate the cause.

UPM Tachometer.

MPH Speedometer, odometer and trip meter. The speedometer is graduated in MPH and the odometer shows the total mileage of the vehicle.

 Brake warning light. Glows red to indicate excessive brake pedal stroke, which means a) one of the two brake line circuits is leaking, or b) the back wheel brakes need adjusting.

If this light comes on, investigate the cause of the trouble without delay and have the fault repaired by an authorized Saab dealer.

 Direction indicator repeater light. Flashes green in time with the direction indicators.

 High beam warning light. Glows blue when the headlights are on high beam.

INSTRUMENTS

Removal of instrument insert

1. Back off and remove the four screws holding the instrument insert. Pass the speedometer cable in from the engine compartment. Take out the instrument insert. Disconnect the speedometer cable.



REMOVAL OF INSTRUMENT INSERT

2. Disconnect the electric cables and note their respective connection positions.

The instrument concerned can now be detached from the insert by opening up the retaining clamps. Repairs and adjustments of instruments should always be entrusted to a specialist firm.

Reinstall in the reverse sequence. Pull the speedometer cable back into the engine compartment.

Replacement of speedometer cable with sheathing

When handling the speedometer cable, never coil it in rings with a diameter of less than about 12 inches (300 mm), since otherwise there is a risk that the flexible inner wire may get damaged, which could cause unwanted noise after installing.

1. Back off and remove the four screws holding the instrument insert. Pass the speedometer cable in from the engine compartment. Take out the instrument insert. Disconnect the speedometer cable.
2. Remove the rubber bushing in the dash panel and pull the cable out.
3. Detach the cable from the gearbox.

Install the new cable in the reverse sequence. Pull the cable out into the engine compartment so that it lies smoothly and without any sharp bends.

Seal the bushing in the dash panel with a suitable sealing compound.

Changing light bulbs in instruments

1. Back off and remove the four screws holding the instrument insert. Pass the speedometer cable in from the engine compartment. Take out the instrument insert.
2. Remove the appropriate bulb holder and change the bulb. Refit the holder.
Note that the bulb holders in the fuel and temperature gages are equipped with a bayonet socket.
3. Refit the instrument insert. Pull the speedometer cable back into the engine compartment.

ELECTRICAL ACCESSORIES

Radio installation

The most suitable position for installation of the radio receiver is in the space provided for this purpose in the instrument panel. The door in the panel must then be removed.

The installation is prepared in that cables are drawn to the door in the instrument panel.

The most suitable position for installation of the loudspeaker is under the grille located above the instrument panel.

Location of antenna

When fitting the antenna, proceed in accordance with the manufacturer's instructions.

Suppression of radio interference

The engine is supplied with a suppressed rotor and suppressed spark plug terminals and consequently no additional resistances need be fitted on HT wires at the ignition coil and distributor. The use of extra shielding in the ignition cables has an adverse effect on the spark at the plugs, resulting in reduced engine output.

Extra lights

Provisions are made for the installation of extra lights in that cables are fitted as far as the two jointing pieces mounted one on each side of the radiator. A switch is fitted in the instrument panel.

The most suitable position for installation of the headlamps is in the space provided for this purpose behind the grille.

The extra lights can be switched on only when the headlamps are on high beam, but they can also be used for "flashing" with the dimmer switch if the headlamps are dipped and the switch for the extra lights is switched on.

Electrical accessories

General

All electrical accessories must be properly fused off and connected to the ignition lock or to the fuse block.

It should nevertheless be borne in mind that the loading on the ignition lock may not exceed that of the standard equipment by more than 10 A.

The wiring for the electrical accessories should be so dimensioned as to ensure the least possible voltage drop.

As a general rule, the following applies:

Current consumption less than 8 A (96 W): use a wire with a cross-sectional area of 0.002 in. (1.5 mm).

Current consumption more than 8 A (96 W): use a wire with a cross-sectional area of 0.003 in. (2.5 mm).

For all connections and splices made when installing electrical accessories, use AMP crimped terminals.

Heating and ventilation system

General

The arrangement comprises a separate system, connected to the cooling system. The air flows into a collection box through the air intake in front of the windshield, continuing from there through a splash guard into the fan and heat exchanger and on through the damper housing into the passenger compartment. The fan and the heat exchanger have separate, but communicating, casings. The air is warmed up as it passes the heat exchanger which, in its turn, is heated by the cooling water. The temperature can be varied with the thermostat-controlled heating cock. The thermometer bulb is located in the current of air injected into the passenger compartment. The air from the heat exchanger first passes a damper housing, where it is distributed to the lower, front part of the passenger compartment via two air dampers. Branch lines on the damper housing regulate the air supply to the windshield defroster jets.

On the upper part of the heater unit there are two separate fresh-air vents, which open out on the instrument panel through two adjustable jets.

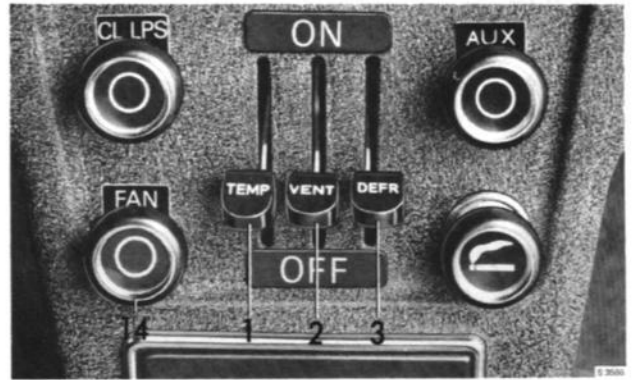

HEATING AND VENTILATION CONTROLS

1. Temperature control
2. Air control, floor
3. Air control, defroster
14. Fan motor switch

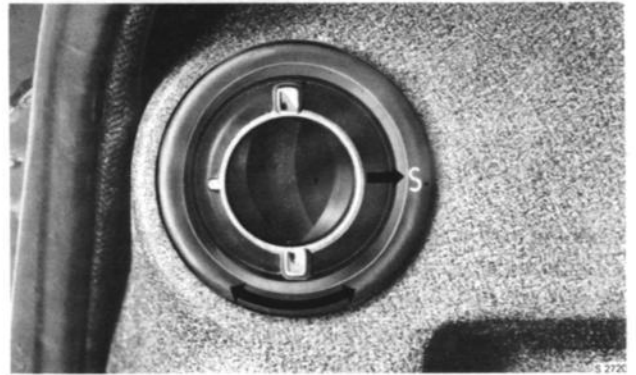

ADJUSTABLE FRESH AIR VENT

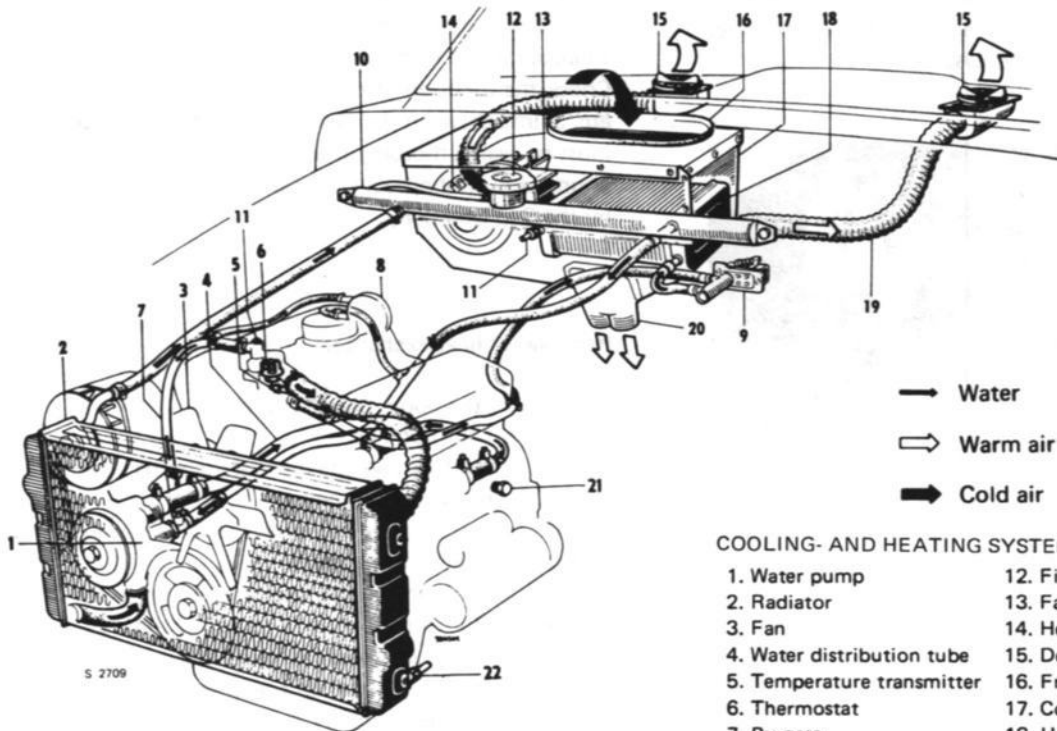

- Water
- ⇨ Warm air
- ⇦ Cold air

COOLING- AND HEATING SYSTEM

- | | |
|----------------------------------|-------------------------------|
| 1. Water pump | 12. Filling cap |
| 2. Radiator | 13. Fan wheel |
| 3. Fan | 14. Heater fan motor |
| 4. Water distribution tube | 15. Defroster jet, adjustable |
| 5. Temperature transmitter | 16. Fresh-air intake |
| 6. Thermostat | 17. Collector box |
| 7. By-pass | 18. Heater core |
| 8. Water jacket, automatic choke | 19. Defroster hose |
| 9. Thermostat valve | 20. Air inlet |
| 10. Expansion tank | 21. Drain plugs (2) |
| 11. Bleeding nipples | 22. Drain valve |

The fan motor is switched on and off by a switch with two positions. In addition, the motor up to and incl. chassis No. 71501200 can be set at the summer position (high speed) and winter position (low speed) by simple switching of the connection piece on the wall behind the windshield washer.

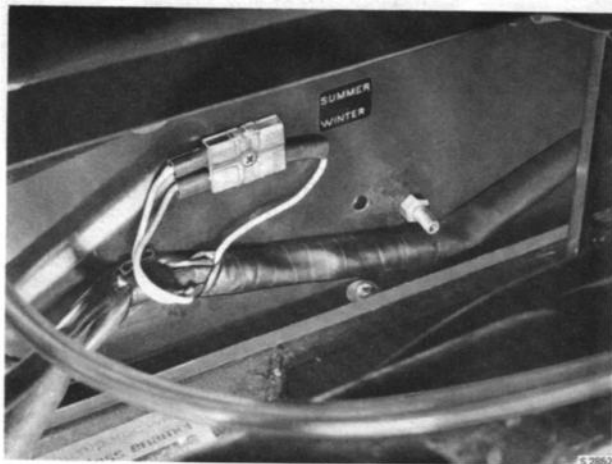

SUMMER - WINTER POSITIONS, FAN MOTOR AND HEAT EXCHANGER BLEED NIPPLE, UP TO AND INCL. CHASSIS NO. 71501200

When the road speed exceeds 30 mph. (50 km/h), the speed wind is usually sufficient to ensure satisfactory function of the heating system. Consequently, it is only necessary to use the fan when the car is being driven at a relatively low speed.

The heat exchanger is fitted with a bleed nipple enabling it to be bled whenever the cooling system is refilled. The passenger compartment is ventilated through two grilles at the sides of the roof and via channels to outlets located behind the openable side windows.

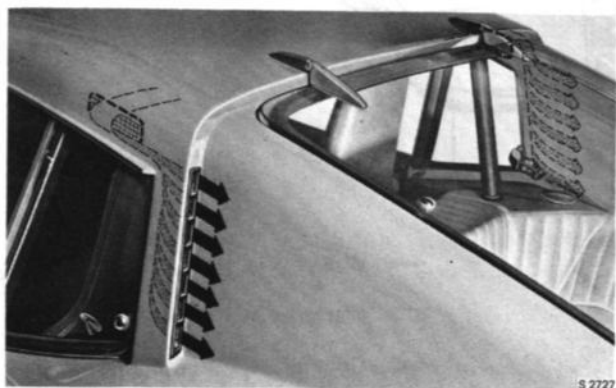

VENT CHANNELS

Removal of fan motor

1. Take off the hood. See Group 8.
2. Back off and remove the nine self-tapping screws retaining the heater box cover.
3. Back off and remove the screws for the heat-exchanger cover and remove the cover.
4. Back off and remove the retaining screw for the fan casing. Disconnect the cables and note their respective locations. Lift out the fan.

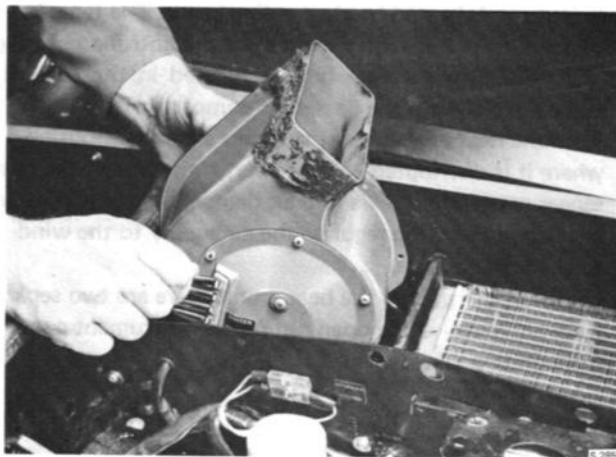

REMOVAL OF FAN CASING

5. Remove the screws holding the fan motor to the cover and lift out the motor.

The fan motor and impeller are balanced together in order to ensure vibrationfree running. An exchange system is operative in respect of the complete fan unit. Reinstall in the reverse sequence.

Check the function of the fan before refitting the cover, etc. Joints between the fan casing, heater box and cover must be sealed thoroughly with a suitable sealing compound, e.g. Ribbonseal EC 2185, which is manufactured by the 3-M Company.

Removal of heat exchanger

1. Take off the hood. See Group 8.
2. Drain off the coolant.
3. Back off and remove the nine self-tapping screws retaining the heater box cover.
4. Back off and remove the screws for the heat-exchanger cover and remove the cover.
5. Back off and remove the retaining screw for the fan casing and turn the casing aside out of the way.
6. Disconnect the hoses to the heat exchanger.
7. Remove the front panel on the heater box. If necessary, remove also the container for the windshield washer liquid.

8. Lift out the heat exchanger.

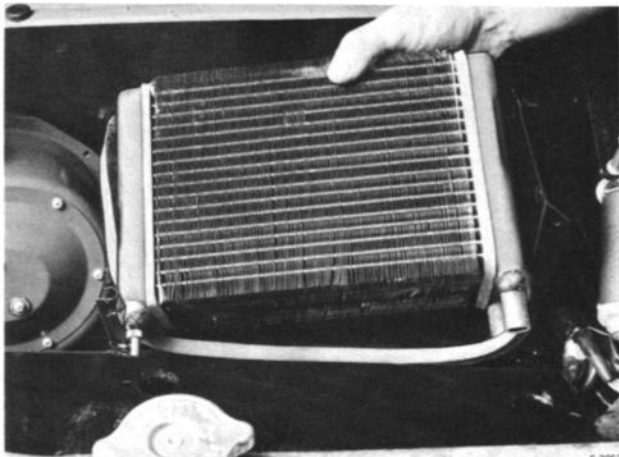

REMOVAL OF HEAT EXCHANGER

Reinstall in the reverse sequence.

Joints between the fan casing, heater box and cover must be sealed thoroughly with a suitable sealing compound, e.g. Ribbonsal EC 2185, which is manufactured by the 3-M Company.

Note the seal around the heat exchanger.

Fill up with coolant and check that there is no leakage at the connections.

Removal of heating system thermostat valve

The cock with valve is located inside the passenger compartment on the left side of the dash panel.

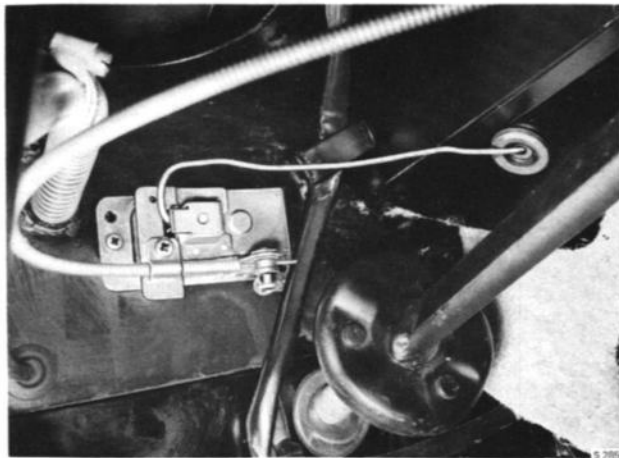

LOCATION OF THERMOSTAT VALVE

1. Drain off the coolant.
2. Disconnect the hoses from the heater cock.
3. Remove the distributor casing for the outlet to the defroster hoses.
4. Disconnect the thermostat coil under the heat exchanger and remove the rubber bushing.

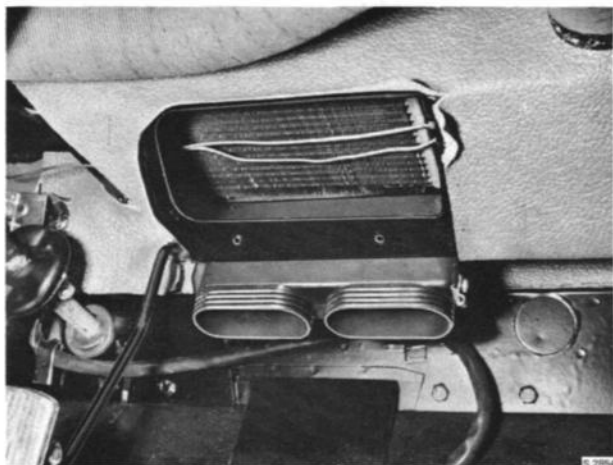

REMOVAL OF DISTRIBUTOR CASING TO FACILITATE DISCONNECTION OF THE THERMOSTAT COIL

5. Detach the control wire from the heater cock.

6. Fold the cowl plate trim aside and detach the heater cock from the cowl plate. Remove the heater cock. Reinstall in the reverse sequence.

Fill up with coolant and check that there is no leakage at the connections.

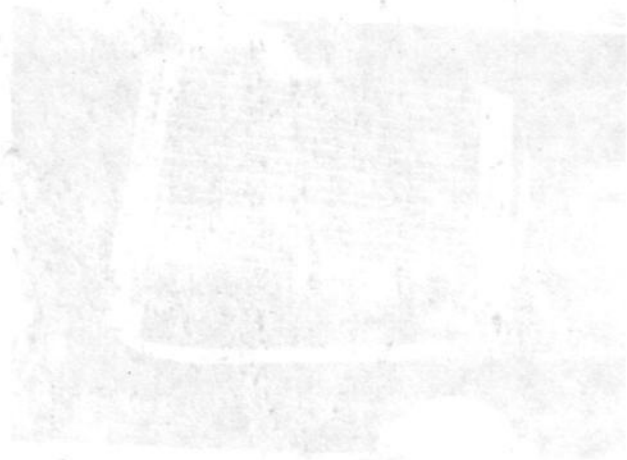
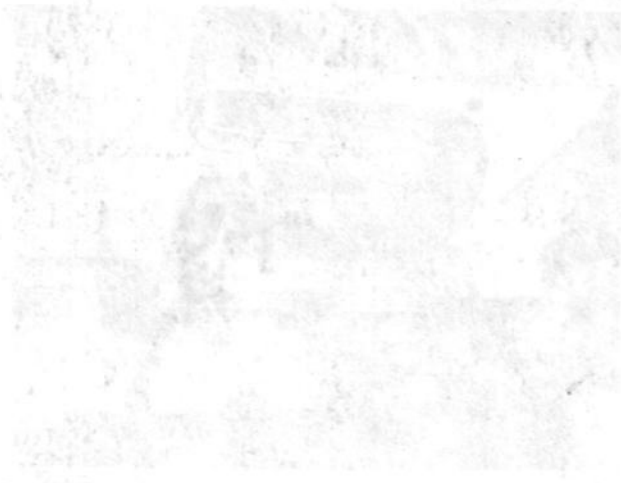

Remove the head assembly from the housing. The head assembly is located at the top of the housing. It is a rectangular component with a central opening. The head assembly is connected to the housing by a series of pins or screws. The head assembly is used to control the flow of fluid through the housing. The head assembly is made of a material that is resistant to corrosion and wear. The head assembly is a critical component of the housing and must be replaced if it becomes damaged or worn.

Removal of head assembly from housing. The head assembly is located at the top of the housing. It is a rectangular component with a central opening. The head assembly is connected to the housing by a series of pins or screws. The head assembly is used to control the flow of fluid through the housing. The head assembly is made of a material that is resistant to corrosion and wear. The head assembly is a critical component of the housing and must be replaced if it becomes damaged or worn.



Remove the head assembly from the housing. The head assembly is located at the top of the housing. It is a rectangular component with a central opening. The head assembly is connected to the housing by a series of pins or screws. The head assembly is used to control the flow of fluid through the housing. The head assembly is made of a material that is resistant to corrosion and wear. The head assembly is a critical component of the housing and must be replaced if it becomes damaged or worn.